

## Nilson

*Design: Lievore Altherr*



### *Description*

Sectional composed of a left or right side element and a left or right chaise lounge. Structure in solid wood and plywood, armrests in curved plywood, padding in non-deformable expanded polyurethane with differentiated densities. Lining in canvas coupled with polyester fibers and Velfodera. Bronzed lacquered cast aluminium feet. Covers in fabrics or leathers as per collection or customer's own material. The covers can be completely and easily removed except for the leather version. Upon request, armrests are available in dark brown cowhide leather with visible cut and sew or upholstered with the leathers available in collection. Optional armrest cushions completely filled with feathers are also available. Made in Italy.

### *Finishes & Materials*

**Feet:** Bronze lacquered cast aluminum.

**Cover:** C.O.M., Fabric Cat. A, Extra, Super, Special, Top or Luxus. Leather Cat. Leather or Leather Extra.

**Armrests:** Dark brown hide leather, Leather Cat. Leather or Leather Extra or same cover as sofa.

\* For more specifications, please refer to the "Finishes & Materials" PDF

## Nilson

### Dimensions

#### SIDE ELEMENTS

**A:** 69"5/8W x 37"D x 30"3/8H

**B:** 81"1/2W x 37"D x 30"3/8H

**C:** 93"1/4W x 37"D x 30"3/8H

**Seat height:** 16"1/2

**Armrest height:** 21"5/8

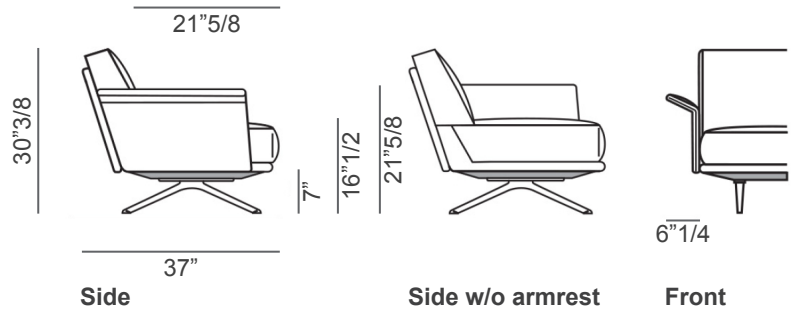

#### LEFT

#### RIGHT

**A**

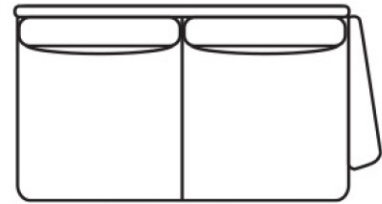
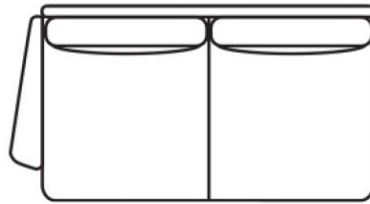

69"5/8

69"5/8

**B**

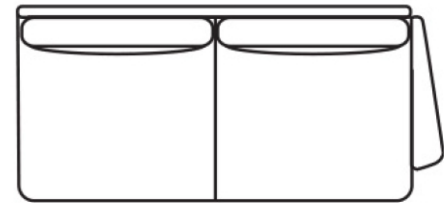
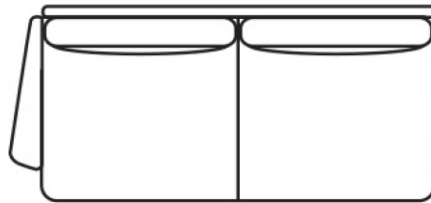

81"1/2

81"1/2

**C**

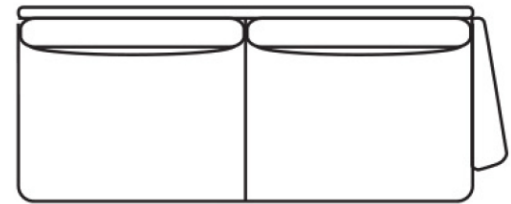
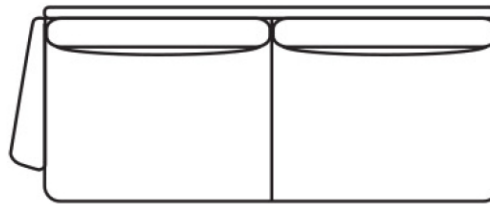

93"1/4

93"1/4

\* For more specifications, please refer to the "Finishes & Materials" PDF

## Nilson

---

### CHAISE LOUNGE

43"5/8W x 60"5/8D x 30"3/8H

Seat height: 16"1/2

Armrest height: 21"5/8

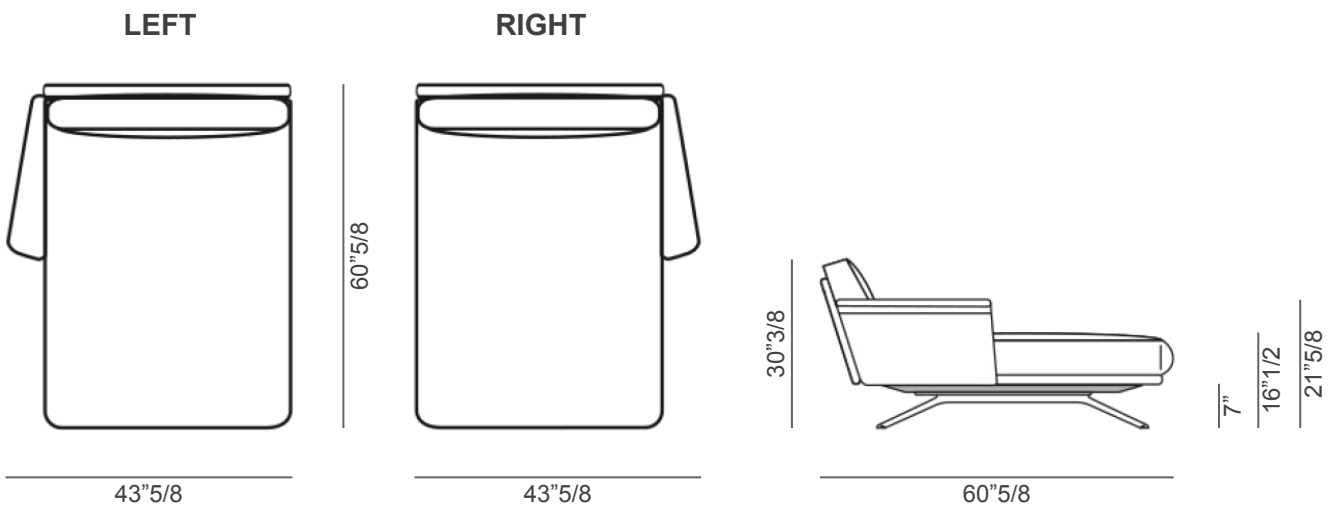

### Suggested armrest cushions:

2x 18"1/2W x 18"1/2H

\* For more specifications, please refer to the "Finishes & Materials" PDF

## Nilson

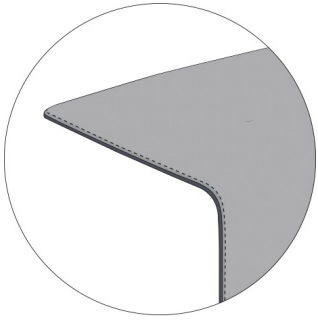

Dark brown hide leather armrest

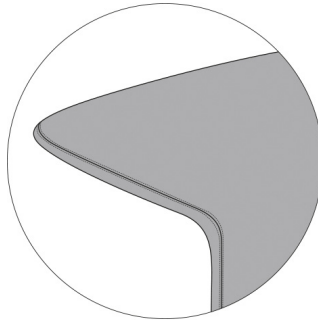

Leather armrest

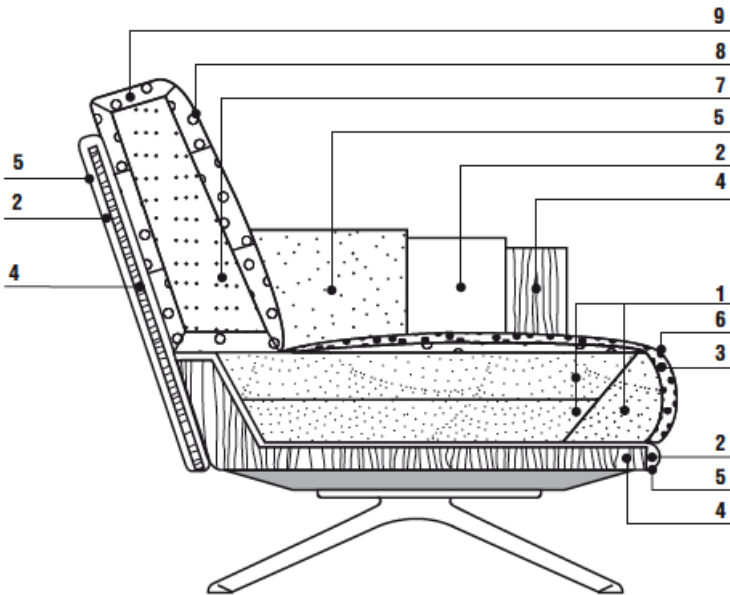

1. Differentiated density polyurethane
2. Polyurethane
3. Polyester fibers
4. Frame in solid wood and plywood
5. Velfodera
6. Fabric lining
7. Polyurethane insert
8. Featherproof fabric cover
9. Feathers

**Feet:**  
Bronze lacquered cast aluminum

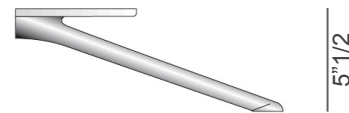

\* For more specifications, please refer to the "Finishes & Materials" PDF