

Boheme



Description

Sectional with tubular metal base in bronzed brass or gold varnished brass, covered in leather. Upholstered in fabrics or leathers as per collection or customer's own material. Various elements available to create compositions for every need. Decorative cushions available upon request. Made in Italy.

Finishes & Materials

Base: Bronzed brass or gold varnished brass and leather cat. B/C/D.
Cover: C.O.M. fabric, technabuk, fabric cat. A/B, C.O.L., leather cat. C/D.
Low table: Calacatta gold, Valentine grey, Emperador dark or Black and gold marble.



* For more specifications, please refer to the "Finishes & Materials" PDF

Boheme

Suggested compositions

Composition A:

164"3/8W x 60"3/4D x 26"5/8H

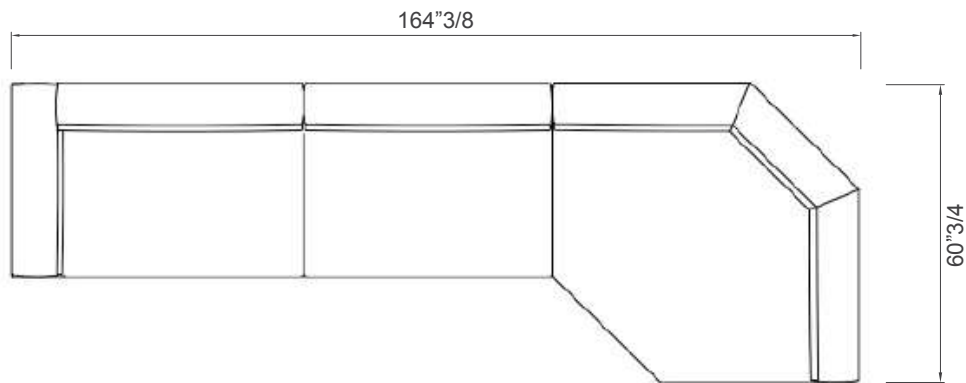

Suggested decorative cushions:

2x 23"5/8 x 23"5/8

2x 19"5/8 x 19"5/8

* For more specifications, please refer to the "Finishes & Materials" PDF

Boheme

Composition B:

164"3/8W x 139"5/8D x 26"5/8H

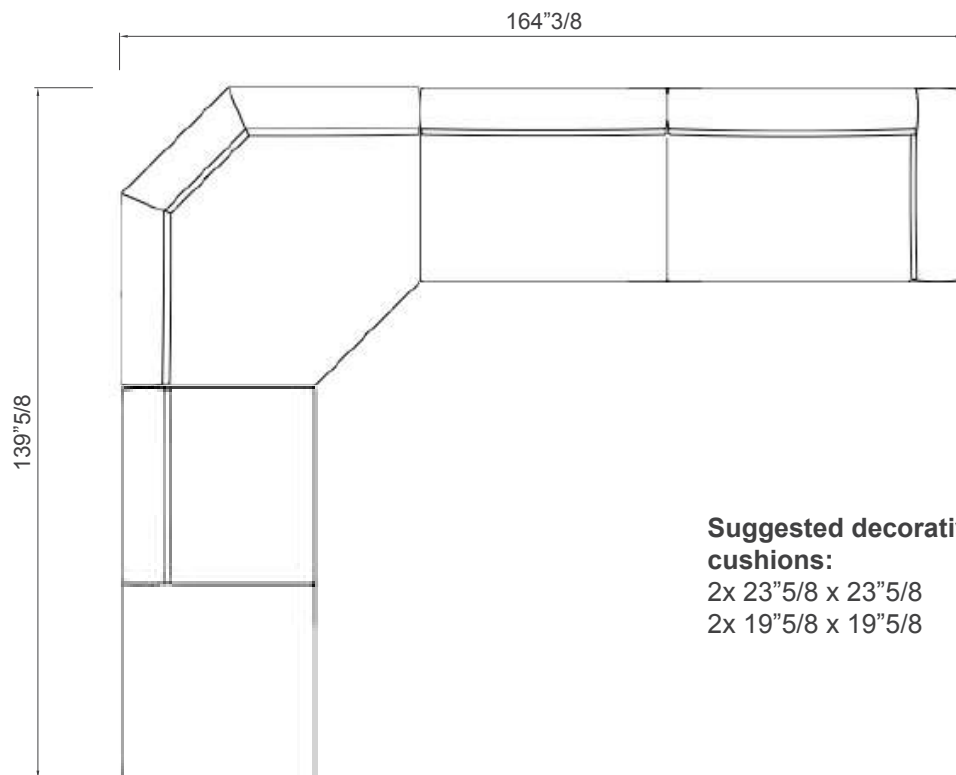

Suggested decorative cushions:

2x 23"5/8 x 23"5/8

2x 19"5/8 x 19"5/8

* For more specifications, please refer to the "Finishes & Materials" PDF

Boheme

Elements

- END UNIT 1:** 72"W x 39"3/8D x 26"5/8H
- END UNIT 2:** 87"3/8W x 39"3/8D x 26"5/8H
- END UNIT 3:** 103"1/2W x 39"3/8D x 26"5/8H
- CORNER UNIT :** 60"7/8W x 60"7/8D x 26"5/8H
- CENTRAL UNIT 2 SEATS:** 78"3/4W x 39"3/8D x 26"5/8H
- CENTRAL UNIT + OTTOMAN:** 78"3/4W x 39"3/8D x 26"5/8H
- CENTRAL UNIT + LOW TABLE:** 78"3/4W x 39"3/8D x 26"5/8H

END UNIT 1

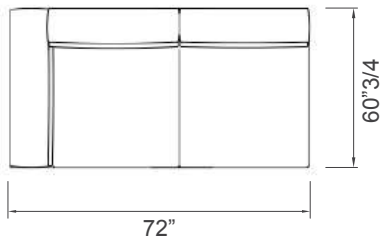

END UNIT 2

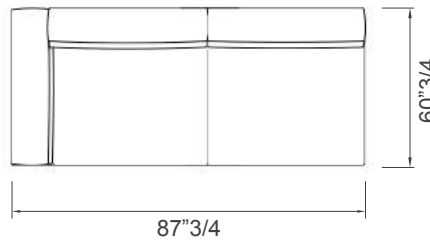

END UNIT 3

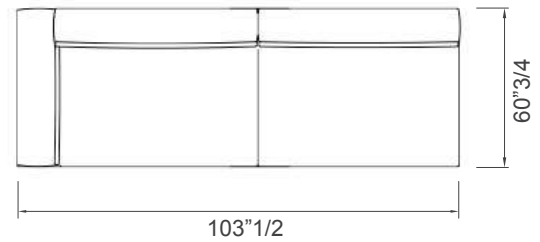

CORNER UNIT

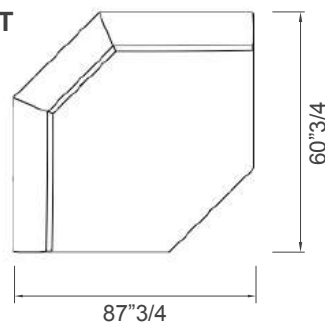

CENTRAL UNIT 2 SEATS

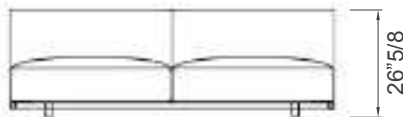

CENTRAL UNIT + OTTOMAN

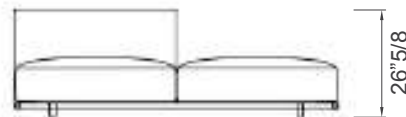

CENTRAL UNIT + LOW TABLE

