

## Clip

*Design: Nika Zupanc*



### *Description*

Double bed with headboard structure in E1 class multilayer wood panels and base structure in multilayer wood panels (MDF) in class E1. Padded headboard and base, with non removable covers for the headboard in fabric or leather and removable covers for the base in fabric or leather. The height-adjustment option for the slats, allows total or partial integration of the mattress. Available in American Queen and American King size. Made in Italy.



\* For more specifications, please refer to the "Finishes & Materials" PDF

## Clip

### Dimensions

#### Queen Size

84"5/8W x 96"3/8D x 33"1/2H  
(To fit American Queen Size mattress: 60" x 80")

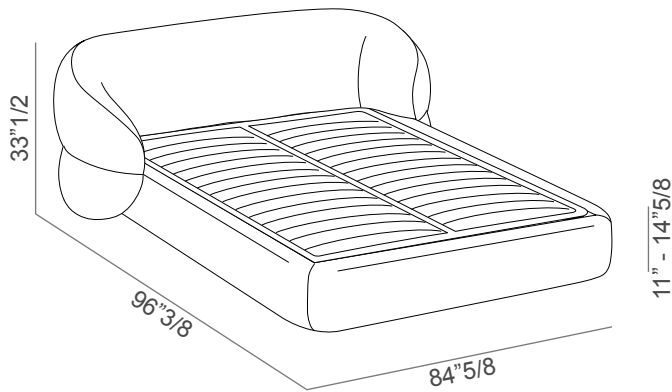

#### King Size

100"3/8W x 96"3/8D x 33"1/2H  
(To fit American King Size mattress: 76" x 80")

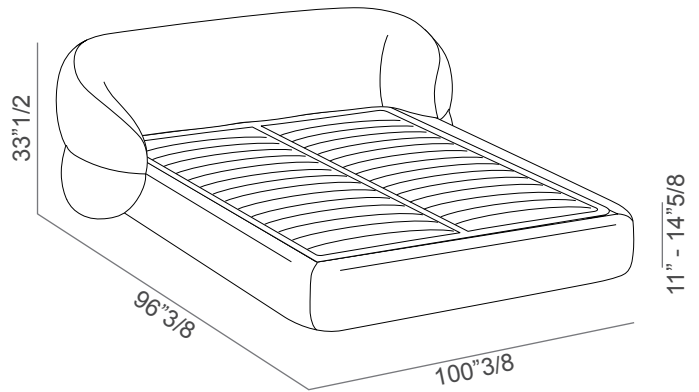

### Internal composition:

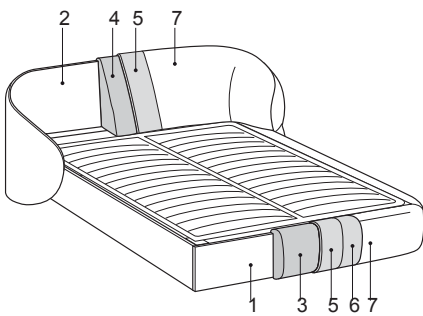

- 1, 2. Structure
- 3, 4, 5, 6. Padding
- 7. Upholstery

#### Headboard

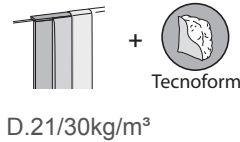

#### Base

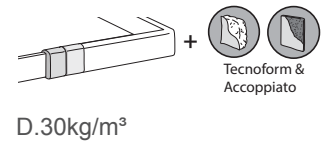

### Versions



\_ fabric

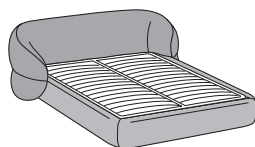

\_ leather

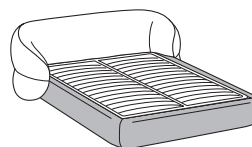

\_ mix  
fabric/leather

\* For more specifications, please refer to the "Finishes & Materials" PDF