

# Atollo

*Design: Paolo Grasselli*



## *Description*

Suspension lamp with white polyethylene diffuser. Different colors available on demand, for minimum purchasing quantity (10 pcs.) with a price increase. Made in Italy.

## *Finishes and materials*

**Diffuser:** White polyethylene. ○



(For more specifications, please refer to “Finishes & Materials”)

## Atollo

### Dimensions

**A:** Ø27"1/2 x 7"7/8H (3 steel cables: 11"7/8H)

**B:** Ø39"3/8 x 8"5/8H (4 steel cables: 11"7/8H)

**C:** Ø59" x 11"H (4 steel cables: 11"7/8H)

**D:** Ø27"1/2 x 7"7/8H (1 steel cable: 78"3/4H)

**E:** Ø39"3/8 x 8"5/8H (1 steel cable: 78"3/4H)

**F:** Ø59" x 11"H (1 steel cable: 78"3/4H)

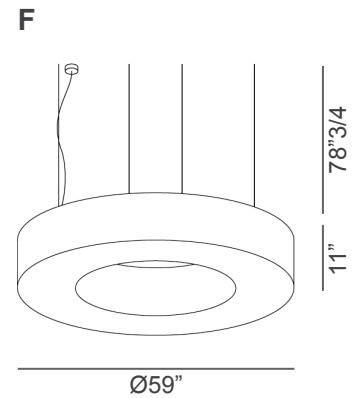
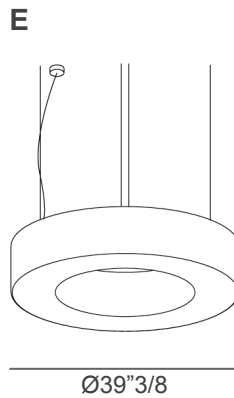
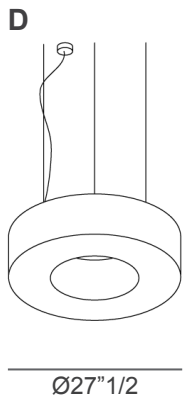
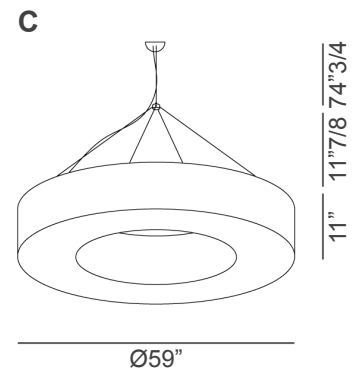
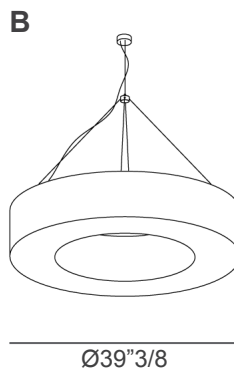
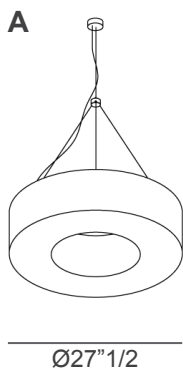

### Canopy detail:

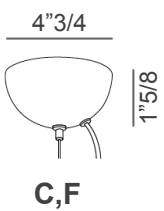
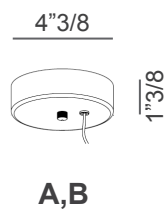
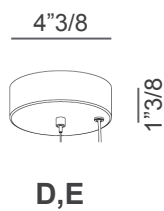

### Accessory: Inner fitting with spotlights

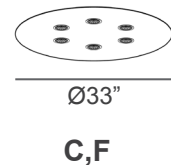

(For more specifications, please refer to "Finishes & Materials")

## Atollo

---

**Light source:**

**A,D:** 6 x E26 - 42W HES

1 led strip 40W - 7000 Lm - 3000 K - No Dimmable or DIM DALI-Push DIM

**B,E:** 8 x E26 - 42W HES

1 led strip 55W - 9300 Lm - 3000 K - No Dimmable or DIM DALI-Push DIM

**C,F:** 12 x E26 - 42W HES

1 led strip 82W - 14000 Lm - 3000 K - No Dimmable or DIM DALI-Push DIM

(For more specifications, please refer to "Finishes & Materials")