

Conversation

Design: Giorgio Soressi



Description









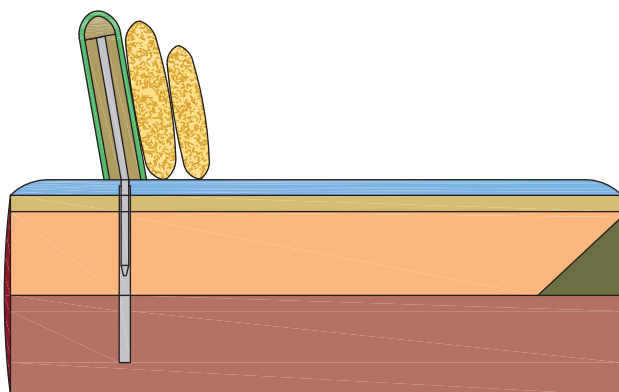

Sofa or sectional frame in solid wood and multilayer wood, springing system with elastic webbing, padded with non-deformable polyurethane foam PF 40/TL, T30/C, T18/S and covered with Dacron 808 T Du Pont. Non-visible plastic feet.

Back: Steel frame, padded with non-deformable polyurethane foam 40/PH and covered with polyester fibre 200gr/m² + velveteen. Back cushion: 100% cotton-fabric filled with piumafill: 70% natural goose feather + 30% polyester fibre HCS.

Covers can be made with fabric or leather and are removable on optional cushions.

Composition



-  Polyurethane 40/TL (6,6 kPa)
-  Polyurethane T 30/C (2,7 kPa)
-  Polyester fiber 200 gr/m².
-  Polyurethane T/18S (1,5 kPa)
-  Natural goose feather
-  Polyurethane 40/PH (8,0 kPa)
-  Dacron 808 T Du Pont
-  Polyurethane PF 40/M (3,3 kPa)
-  Frame in solid and multilayer wood
-  Steel structure
-  Plastic Feet

Conversation

Dimensions

- A: 120"W X 74"3/4D x 33"1/2H
- B: 120"W X 89"3/4D x 33"1/2H
- C: 135"W X 89"3/4D x 33"1/2H
- D: 135"W X 104"3/4D x 33"1/2H
- E: 150"W X 74"3/4D x 33"1/2H
- F: 150"W X 104"3/4D x 33"1/2H

Composition A

Terminal unit 2 seater left 74"3/4 + Chaiselongue right 74"3/4
120"W X 74"3/4D x 33"1/2H

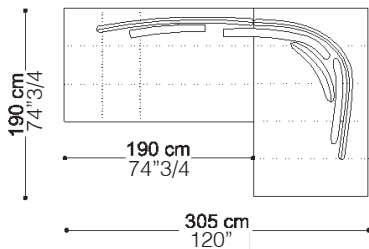

Composition B

Terminal unit 2 seater left 74"3/4 + Chaiselongue right 89"3/4
120"W X 89"3/4D x 33"1/2H

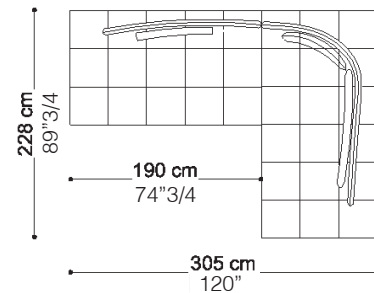

Composition C

Terminal unit 3 seater left 89"3/4 + Chaiselongue right 89"3/4
135"W X 89"3/4D x 33"1/2H

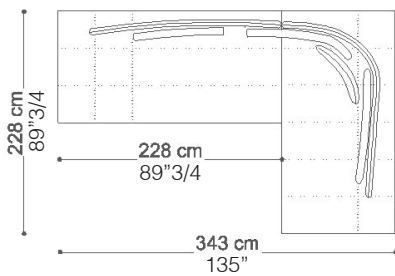

Composition D

Terminal unit 3 seater left 89"3/4 + Chaiselongue right 104"3/4
135"W X 104"3/4D x 33"1/2H

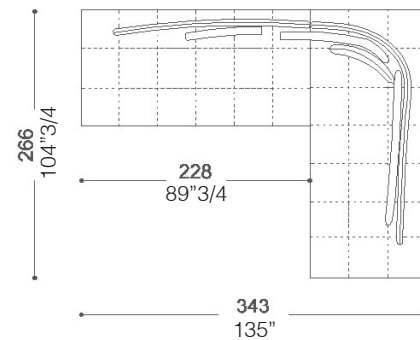

Composition E

Terminal unit 4 seater left 104"3/4 + Chaiselongue right 74"3/4
150"W X 74"3/4D x 33"1/2H

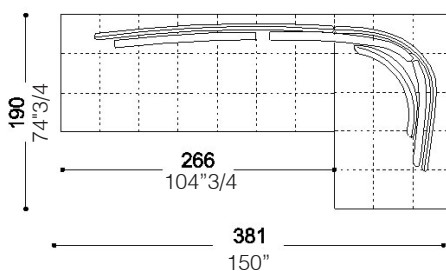

Composition F

Terminal unit 4 seater left 104"3/4 + Chaiselongue right 104"3/4
150"W x 104"3/4D x 33"1/2H

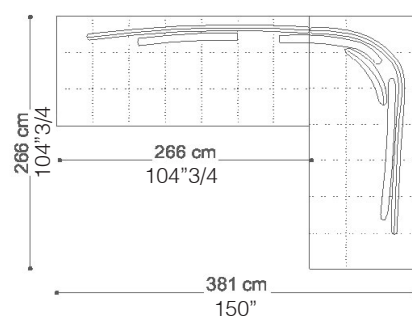

Conversation

Dimensions

Box cushion: 23"5/8 x 23"5/8

Loose pillow: 21"5/8 x 21"5/8

Back cushion: 37"3/8 x 19"5/8

Back cushion: 44"7/8 x 19"5/8

Back cushion: 52"3/8 x 19"5/8

Box cushion
23"5/8 x 23"5/8



Loose pillow
21"5/8 x 21"5/8



Back cushion
37"3/8 x 19"5/8



Back cushion
44"7/8 x 19"5/8



Back cushion
52"3/8 x 19"5/8



Finishes and materials

Covered in: Fabric (Cat. 1,2,3 and Super) or Leather (A,B,C and Extra).
Feet: Plastic (Non-visible).

(For more specifications, please refer to "Finishes & Materials")