

## Culture Club

Design: Giorgio Soressi



### Description







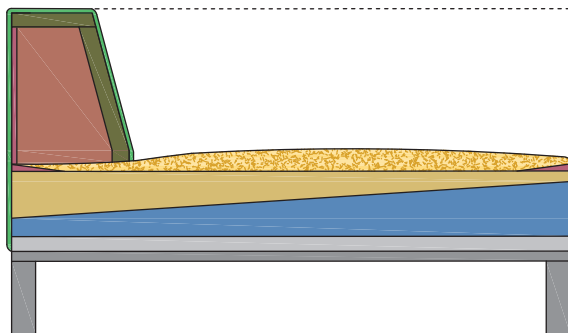

Sofa or sectional frame in solid wood and multilayer wood, springing system with elastic webbing, padded with non-deformable polyurethane foam with different densities, 100% cotton-fabric filled with natural goose feather and polyester fibre 200g/m<sup>2</sup>.

Steel feet with powder finish.

Covers can be made with fabric or leather and are removable on optional cushions.

### Composition



-  Polyester fiber 200 gr/m<sup>2</sup>.
-  Polyurethane 40/TL (6,6 kPa)
-  Polyurethane T 30/C (2,7 kPa)
-  Frame in solid and multilayer wood
-  Natural goose feather
-  Polyurethane 75/SR (14,0 kPa)
-  Polyurethane T 30/E (4,0 kPa)
-  Steel frame
-  Steel feet with powder finish

## Culture Club

### Dimensions

Loose Pillow: 40"1/8 x 26"3/8  
 Loose Pillow: 26"3/8 x 26"3/8  
 A: 115"W x 39"3/8D x 26"H  
 B : 111"7/8W x 87"3/8D x 26"H  
 C: 126"3/4W x 102"3/8D x 26"H

Loose Pillow  
 40"1/8 x 26"3/8

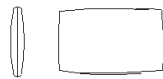

Loose Pillow  
 26"3/8 x 26"3/8



Composition A  
 Terminal unit with 1 arm left 57"1/2 + Terminal unit with 1 arm right 57"1/2  
 115"W x 39"3/8D x 26"H

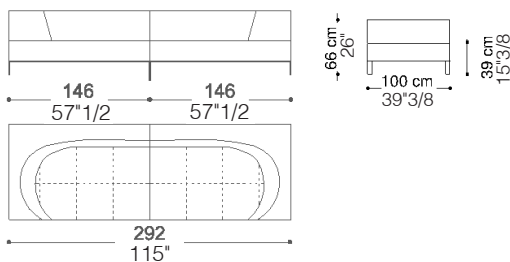

Composition B  
 Terminal unit with 1 arm left 72"3/8 + Sofa 3 seater with 2 arms  
 87"3/8  
 111"7/8W x 87"3/8D x 26"H

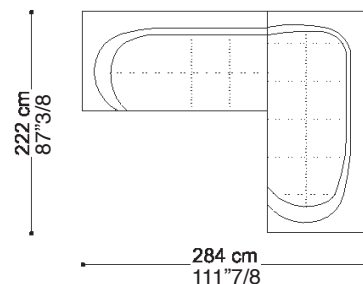

Composition C  
 Terminal unit with 1 arm left 87"3/8 + Sofa 4 seater with 2 arms  
 102"3/8  
 126"3/4W x 102"3/8D x 26"H

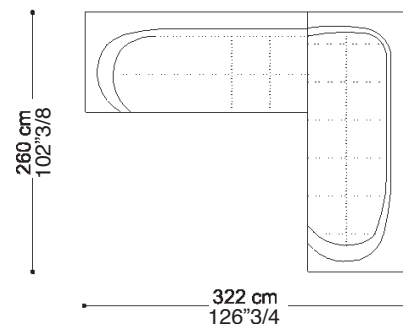

### Finishes and materials

Covered in: Fabric (Cat. 1,2,3 and Super) or Leather (A,B,C and Extra).  
 Feet: Steel with powder finish. Available in Bronze, Silver, Night Grey and Black Matte.

(For more specifications, please refer to "Finishes & Materials")