

Rockouture

Design: Giorgio Soressi



Description

Sofa in solid wood and multilayered wood, springing system with crossed elastic webbing, padded with non-deformable polyurethane foam, covered with polyester fibre.





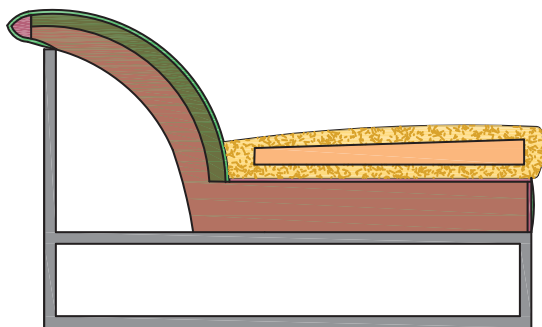

Seat filled with natural goose feather and non-deformable polyurethane foam.

Base is made of stainless steel with bright finish.

Covers can be made with fabric or leather and are removable on optional cushions.

Composition



-  Natural goose feather
-  Polyurethane PF 40/M (3,3 kPa)
-  Polyurethane 40/TL (6,6 kPa)
-  Polyurethane 75/SR (14,0 kPa)
-  P.F. 100 gr/m²
-  Frame in solid and multilayer wood
-  Steel base with bright chrome finish.

Rockouture

Dimensions

Sofa: 104"3/4W x 46"D x 27"1/8H
Box cushion: 23"5/8 x 23"5/8

Sofa 2,5 seater 78"3/4
104"3/4W x 46"D x 27"1/8H
SH: 16"1/2

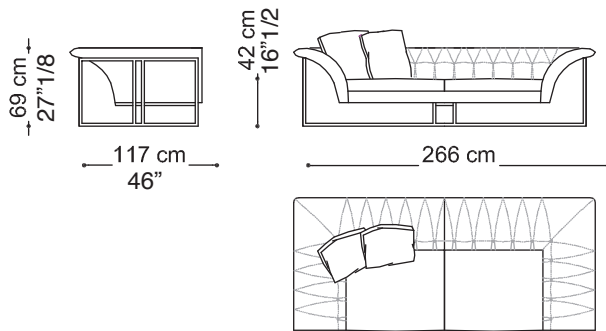

Box cushion
23"5/8 x 23"5/8

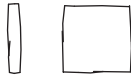

Finishes and materials

Covered in: Fabric (Cat. 1,2,3 and Super) or Leather (A,B,C and Extra).
Also in C.O.M Fabric or C.O.L Leather.

(For more specifications, please refer to "Finishes & Materials")