

## Be Bop

Design: Giorgio Soressi



### Description









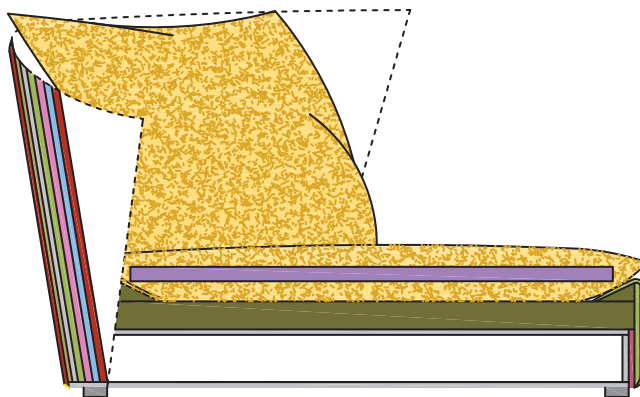

Chaise longue with steel frame, padded with non-deformable polyurethane foam and covered with dacron 808/T Du Pont and polyester fibre. Non-visible plastic feet.

Seat with metal frame, padded with non-deformable polyurethane foam and covered dacron 808/T Du Pont and covered with polyester fibre.

Available with captioneé back.

### Composition



-  Polyester fiber 200 gr/m<sup>2</sup>
-  Polyurethane T 18/S (1,6 kPa)
-  Polyurethane 40/PH (8,0 kPa)
-  Dacron 808 T Du Pont
-  Polyurethane 40/TL (6,6 kPa)
-  Polyurethane T 25/N (4,2 kPa)
-  Natural goose feather
-  Polyurethane PF 35/M (2,8 kPa)
-  P.F. 150 gr/m<sup>2</sup>+ velveteen.
-  Polyurethane 75/SR (14,0 kPa)
-  Steel frame
-  Plastica feet

## Be Bop

---

### *Dimensions*

68"7/8W x 47"1/4D x 41"H  
SH: 13"3/4

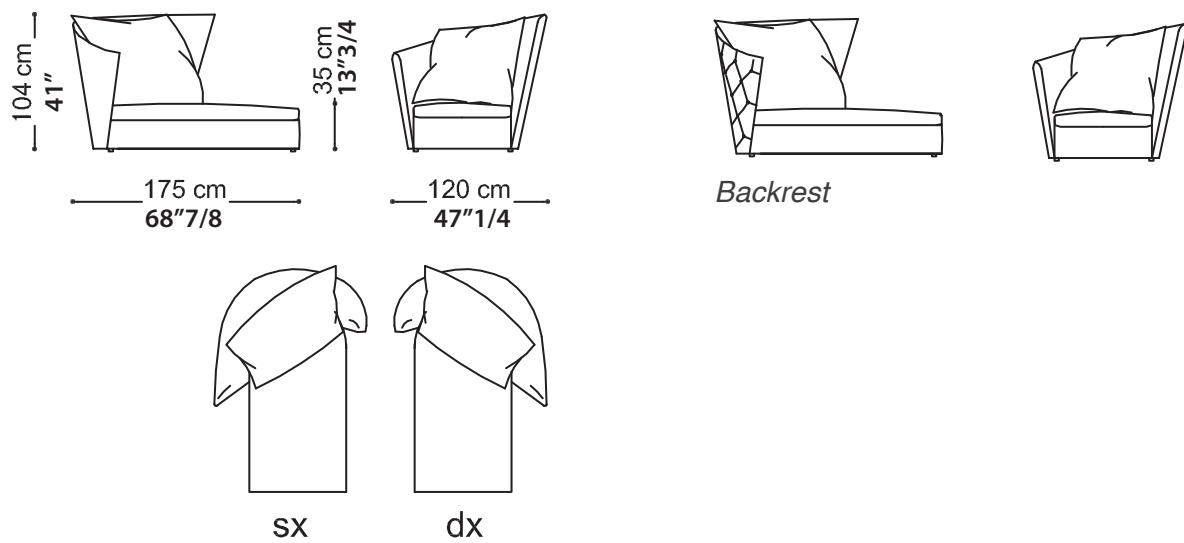

### *Finishes and materials*

Covered in: Fabric (Cat. 1,2,3 and Super) or Leather (A,B,C and Extra).

(For more specifications, please refer to "Finishes & Materials")