

Ibiza

Design: Giorgio Soressi



Description

Sofa with frame in solid wood and multilayer wood, springing system with elastic webbing, padded with non-deformable polyurethane foam and covered with polyester fibre.







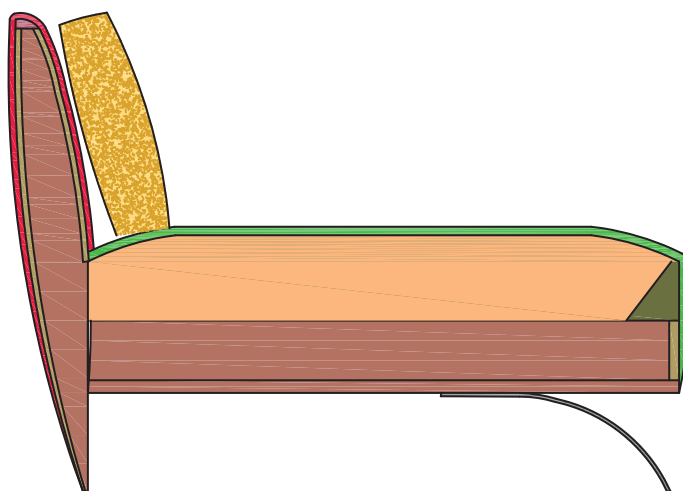

Back cushions cotton-fabric filled with natural goose feather.

Covers can be made with fabric or leather and are removable on optional cushions.

Steel feet with black chrome finish.

Composition



-  P.F. 200 gr/m².
-  Polyurethane 75/SR (14,0 kPa)
-  Polyurethane 40/TL (6,6 kPa)
-  Polyurethane PF 40/M (3,3 kPa)
-  Natural goose feather
-  P.F. 100 gr/m².
-  Polyurethane 40/PH (8,0 kPa)
-  Frame in solid and multilayer wood
-  Steel base with chrome finish

Ibiza

Dimensions

Composition 01: 124"W x 147"3/4D x 15"3/8H

Composition 02: 104"3/8W x 122"D x 15"3/8H

Composition 01 (Angular sofa 3,5 + Terminal unit 3,5):
124"W x 137"3/4D x 28"3/4H
SH: 16"1/2

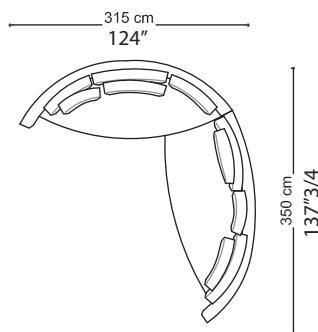

* 9 cushions included.

Composition 02 (Angular sofa 2,5 + Terminal unit 2,5):
104"3/8W x 122"D x 28"3/4H
SH: 16"1/2

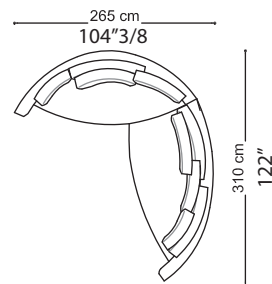

* 8 cushions included.

Back Cushions

Pillow with band and profile
27"1/2 x 16"1/2

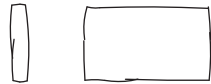

Pillow with band and profile
23"5/8 x 23"5/8



Pillow with band and profile
19"5/8 x 19"5/8



Box cushion
31"1/2 x 15"3/4



Pillow with band and profile
39"3/8 x 17"3/4

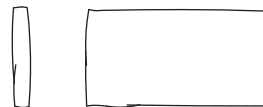

Finishes and materials

Covered in: - Fabric (Cat. 1, Cat. 2, Cat. 3, Cat. Super, Cat. A, Cat. B, Cat.C and Cat. Extra)
- Leather (Cat. A, Cat. B, Cat. C and Cat. Extra).

(For more specifications, please refer to "Finishes & Materials")