

20.Venti Light

Design: 967ARCH



Description

The 20.Venti Light collection is the result of the simplification of the 20.Venti system, to provide a wider offer able to respond to different market needs and was designed to offer an extensive choice of dimensions and finishes for working areas. The collection includes double aggregable desks with a wide range of accessories. An intentionally iconic system that renounces unidentifiable stylistic solutions. Basic minimal style that enhances both design and function.

Rectangular table system available in different versions: for two users, for four users or the Flex version in sizes that can be customized as required by using terminal or intermediate modules in the lengths 63" or 70"7/8. All versions are equipped with cable opening on the top. The melamine tops are finished in matt white, light grey or black colors and the steel frame and legs, section 3/4"x3/4", are painted with epoxy powder in the matt colors white and graphite grey. Adjustable aluminium feet with range of +/- 3/8".

Moreover, a wide selection of accessories such as finishing panel for the side frames of desks, transparent plastic cable spring with aluminum painted base, under-top tray for cable collection, screens with clasp fitting, pc holder on wheels, stationery / document holder accessories and drawer units, are available upon request (see more details on next pages). Made in Italy.

Finishes & Materials

Melamine top: Matt white / Matt light grey / Matt black.

Frame: Matt painted white / Matt painted graphite grey.

Side panels: Melamine (White / Light grey / Black) / Lacquers (Orange / Green / Avio blue / Mustard yellow / Dark red).

* For more specifications, please refer to the "Finishes & Materials" PDF

20.Venti Light

Dimensions

DESK FOR TWO USERS

A) 63"W x 63"D x 29"1/2H

B) 70"7/8"W x 63"D x 29"1/2H

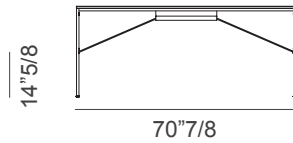
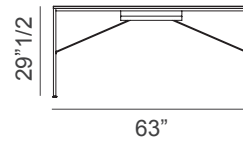
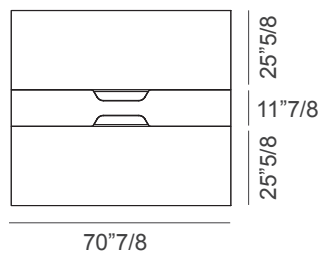
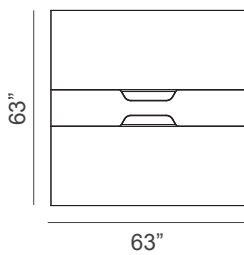
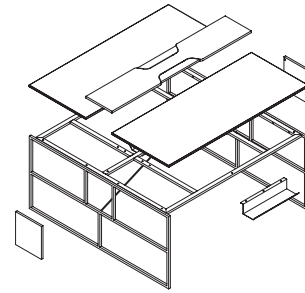
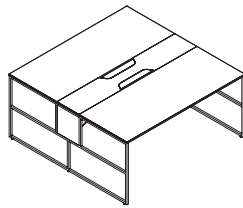

DESK FOR FOUR USERS

A) 126"W x 63"D x 29"1/2H

B) 141"3/4W x 63"D x 29"1/2H

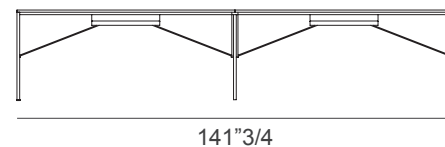
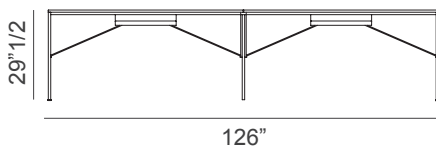
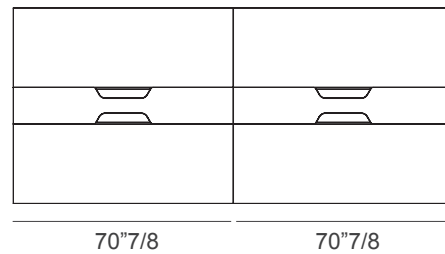
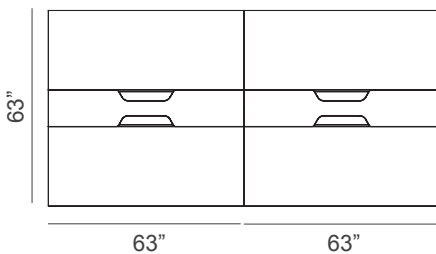
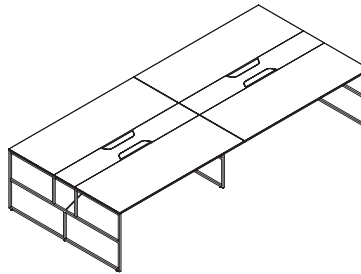

20.Venti Light

CABLE SCHEME

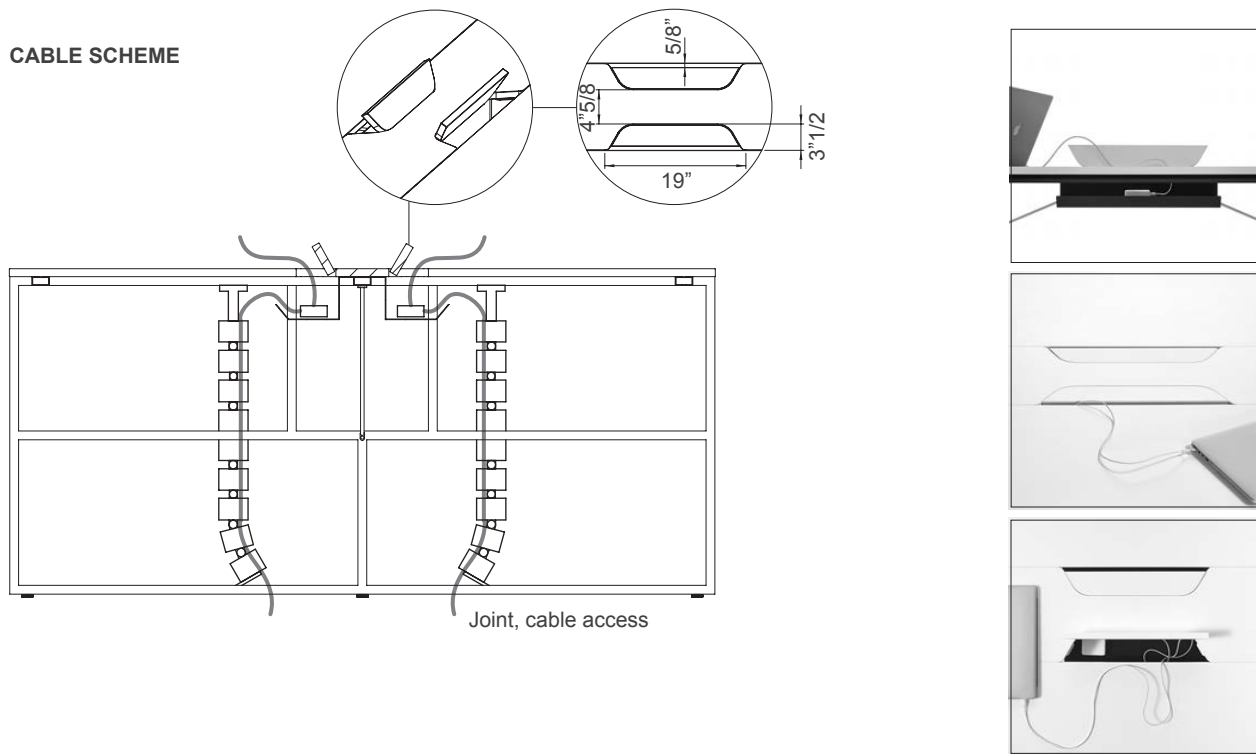

Accessories

Sound-absorption screen

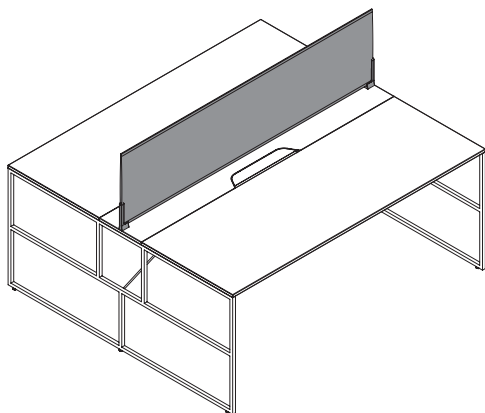

Finishing panel for the frame

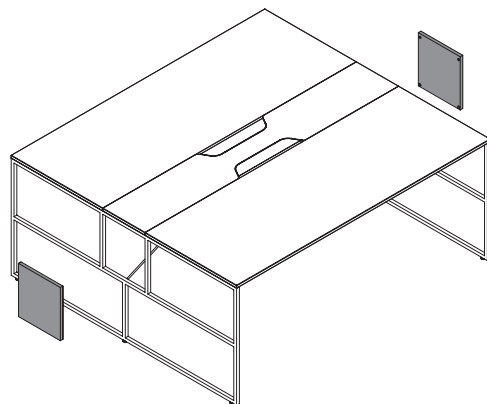

20.Venti Light

Accessories (cont.)



Pc stand with castors

. PC STAND WITH CASTORS:
made of sheet steel painted with epoxy powders in the matt colors white and graphite grey, with castors, in the size: 9"5/8W x 22"5/8D x 22"7/8.

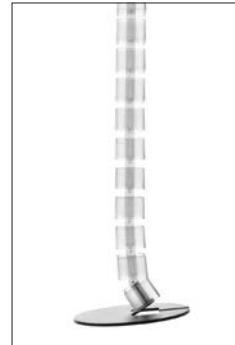

Wireway sleeve

. WIREWAY SLEEVE:
made of flexible, transparent polycarbonate, designed to hold PC and electronic device cables. Secure directly to the structural wireway. Steel base painted with silver epoxy powder, 6"1/2.

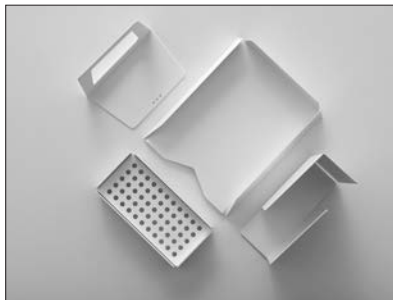

Stationary and document holder: pen holder, bookends, document holder

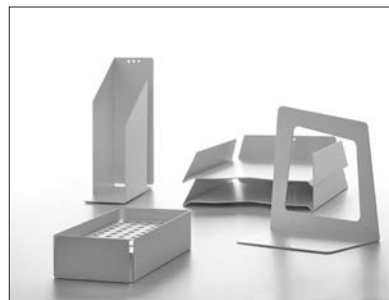

. STATIONARY AND DOCUMENT HOLDER:
made of sheet steel painted with epoxy powders in the matt colors white and graphite grey, available in 2-piece kits, and divided into following options:

Pen holder: 9"7/8 x 4"3/4D x 2"3/8H

Bookends: L21, D13 and H21 cm

Hor. doc. holder: 12"3/4W x 10"1/8D x 2"1/8H

Ver. doc. holder: 3"5/8W x 9"3/8D x 10"7/8H

DRAWER UNIT A / B



stationery drawer

VERSION A THREE DRAWERS + stationery drawer

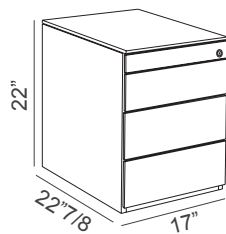
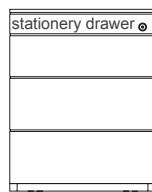

VERSION B DRAWER + FILING UNIT + stationery drawer

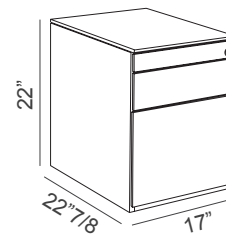
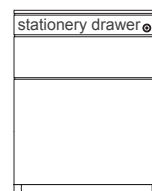

BASIC DRAWER UNIT



stationery tray

BASIC VERSION THREE DRAWERS

