

Roll (Wall fixing)

Design: Dondoli e Pucci

Description

Wall fixing bookcase. Mounting it to the wall takes place by means of supports composed of metal tubes with lead finish.

The shelves and the details that come out of the metal tubes are available in the same finish as the supports or in different finishes, for a play of contrasts of utmost elegance.

The modularity of this bookcase makes it suitable for any space. A box module is also available, to store objects and books.

Maximum capacity: 10 kgs per shelf.
Made in Italy.

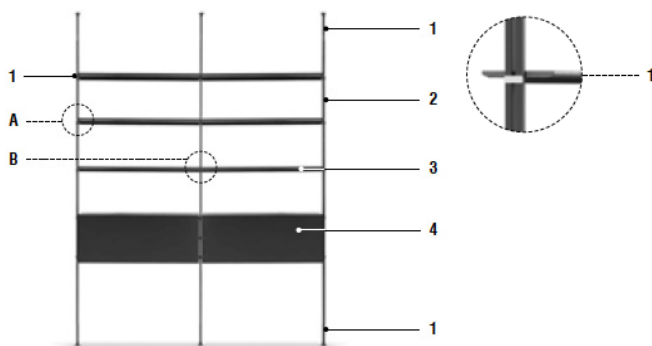

The minimum number of shelves to be placed between two uprights is equal to 2.



1. Upright Details & Clamp: Plus metal.
2. Upright: Plus metal.
3. Shelf: Matt lacquered wood / Veneered wood.
4. Box: Matt lacquered wood.

Roll

Compositions

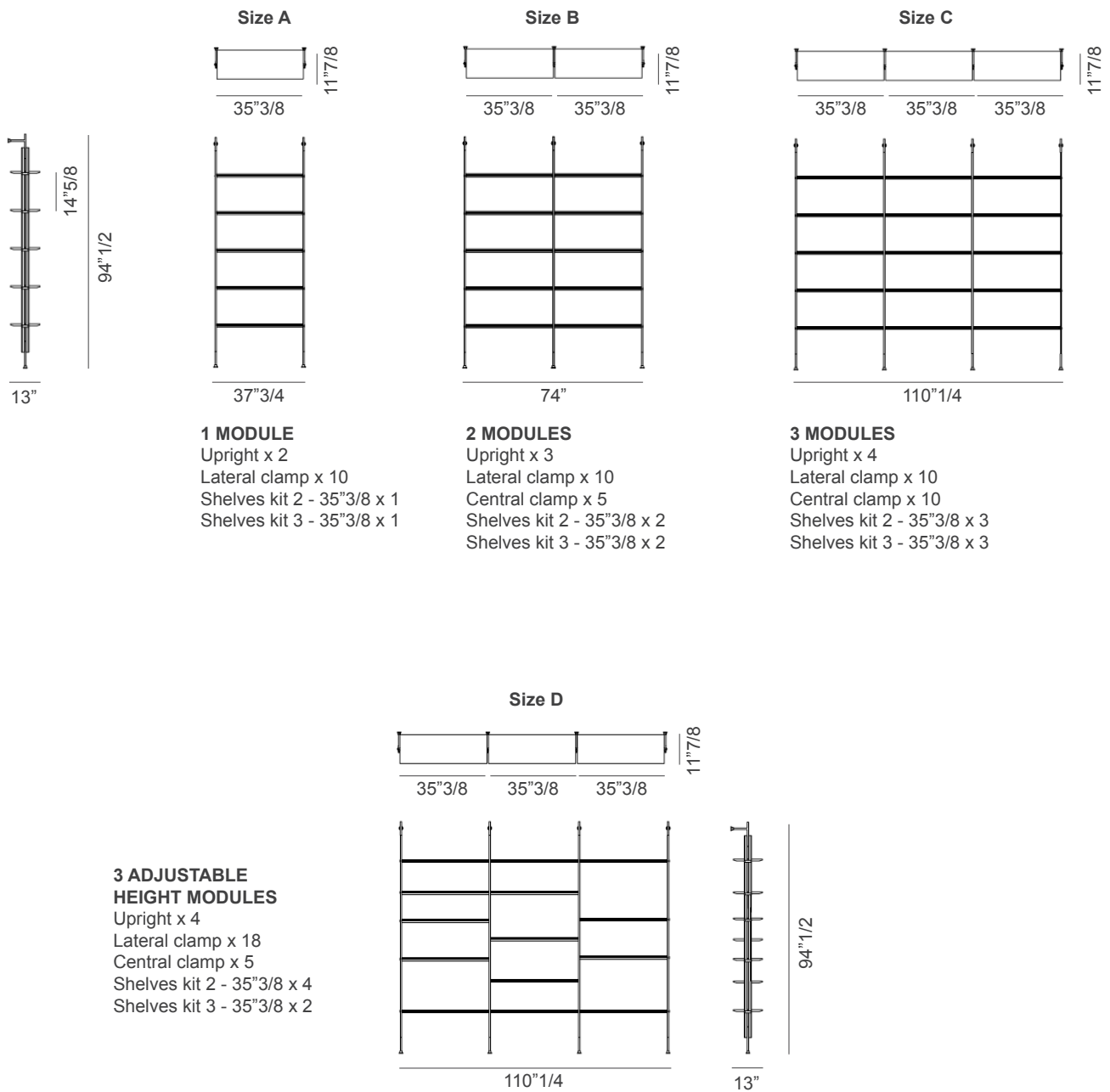

Roll

Compositions (cont.)

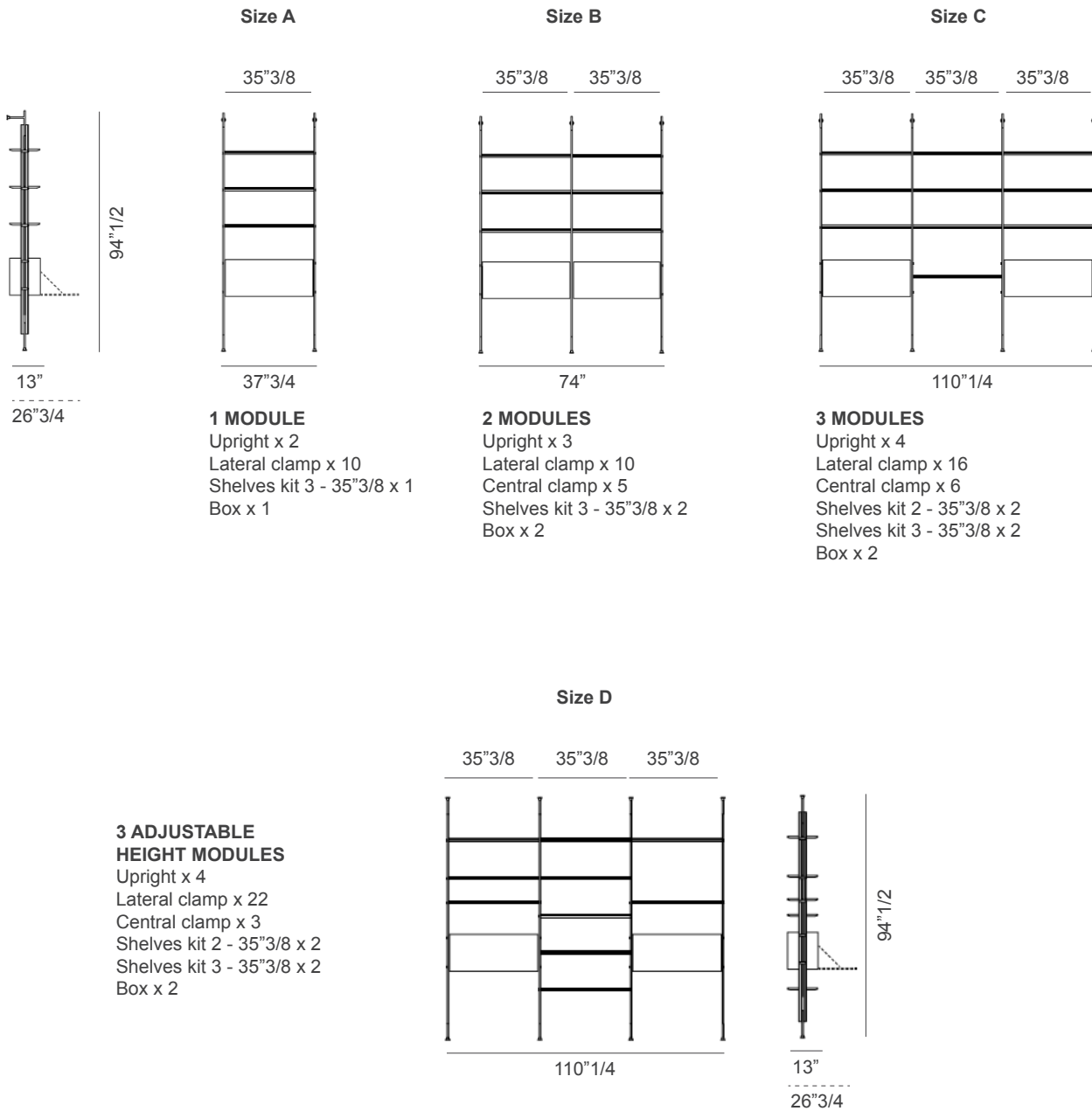

Roll

Elements

2 shelves kit
(shelf: 35"3/8)

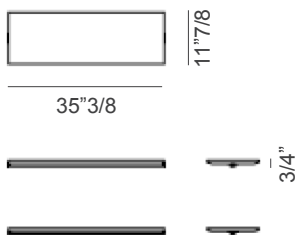

3 shelves kit
(shelf: 35"3/8)

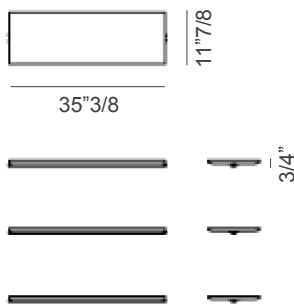

Box

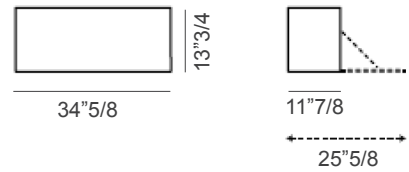

Lateral clamp



Central clamp



2 shelves kit
(shelf: 63")

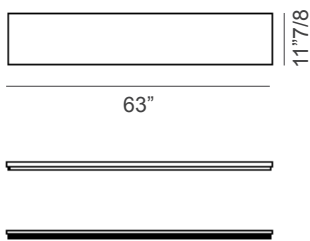

3 shelves kit
(shelf: 63")

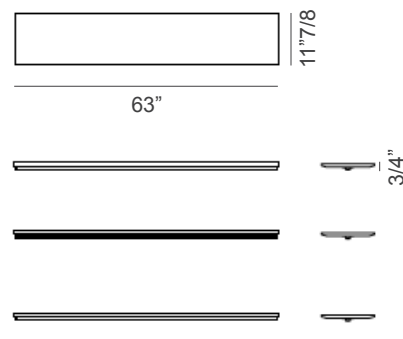

Upright

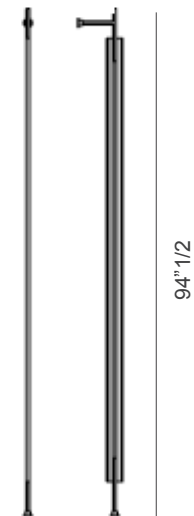

Shelf support 63"

