

## Arlott

*Design: Gabriele & Oscar Buratti*



### *Description*

Modular sofa with structure in solid spruce and beech wood, in various thicknesses. Buffer side in E1 class plywood and particleboard panels; details in hard or cellulose wood fiber panels. The back is made of hard or cellulose wooden fiber panels. Seat with pre-tensioned crossed propylene fiber and latex elastic webbing. Padded seat cushions with memory foam and technoform, with removable covers in fabric and leather. Padded backrest cushions and structure, with removable covers in fabric and non-removable covers in leather. Chromed steel headrest mechanism, six positions adjustable with manual mechanism. Frontal bar available in metal or upholstered in leather. Available in high and low versions. Made in Italy.



\* For more specifications, please refer to the "Finishes & Materials" PDF

## Arlott

HIGH

### Dimensions

- A: 70"7/8W x 39"3/4D x 29"1/2 - 37"3/4H
- B: 133"7/8W x 39"3/4D x 29"1/2 - 37"3/4H
- C: 165"3/8W x 39"3/4D x 29"1/2 - 37"3/4H



A

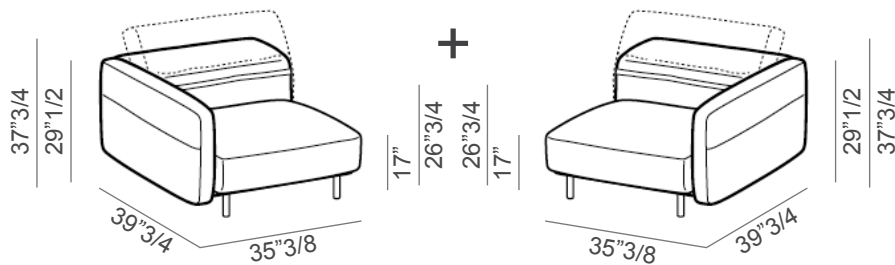

B

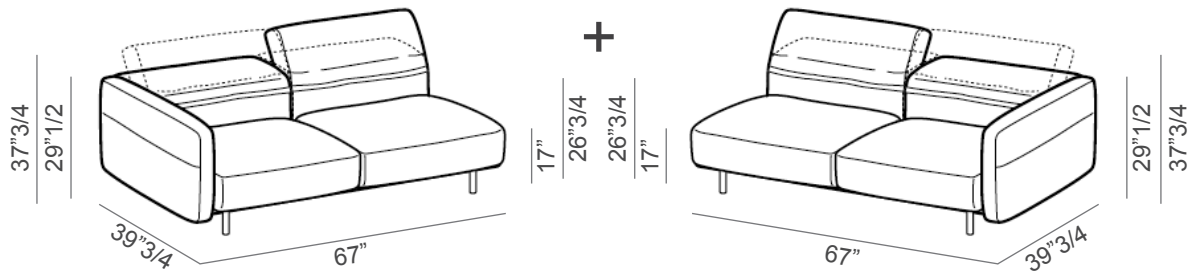

C

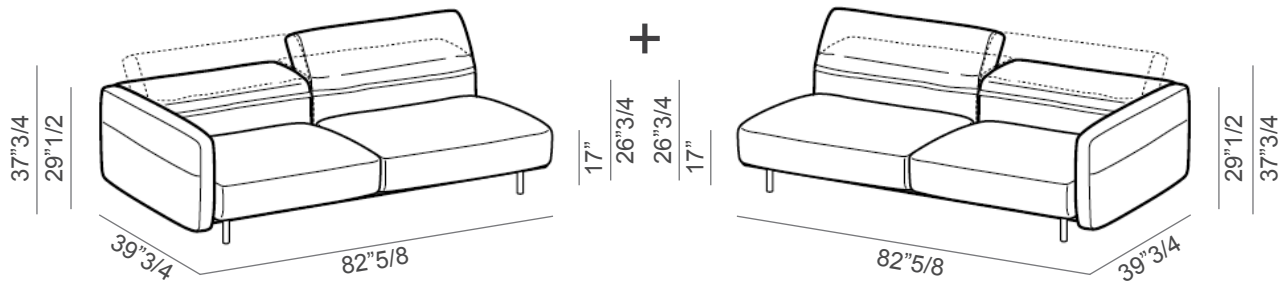

\* For more specifications, please refer to the "Finishes & Materials" PDF

## Arlott

HIGH

### Dimensions

D: 196"7/8W x 39"3/4D x 29"1/2 - 37"3/4H

E: 196"7/8W x 39"3/4D x 29"1/2 - 37"3/4H

F: 244"W x 39"3/4D x 29"1/2 - 37"3/4H

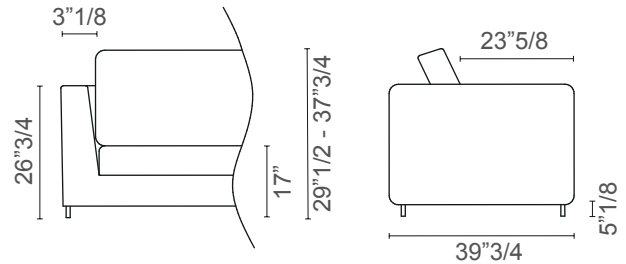

D

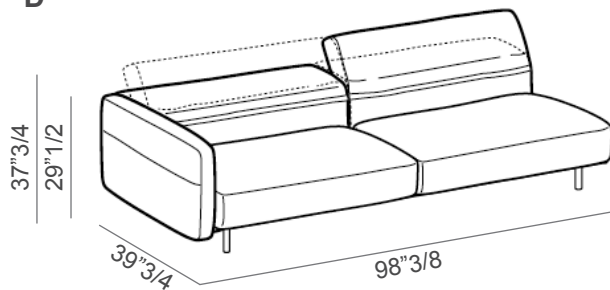

+

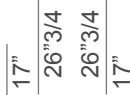

E

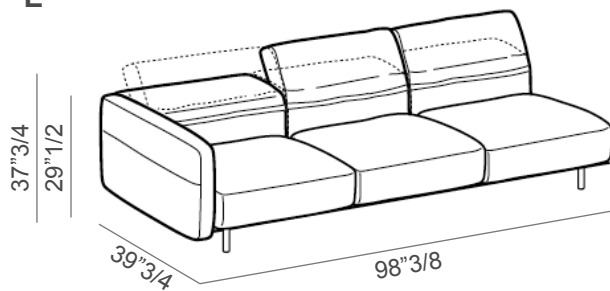

+

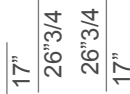

F

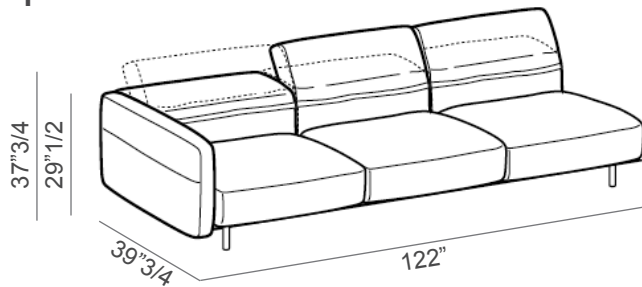

+

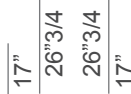

\* For more specifications, please refer to the "Finishes & Materials" PDF

## Arlott

### Internal composition

HIGH

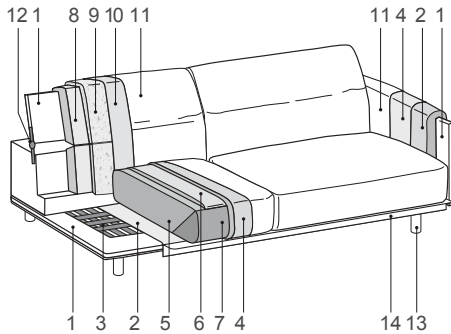

LOW

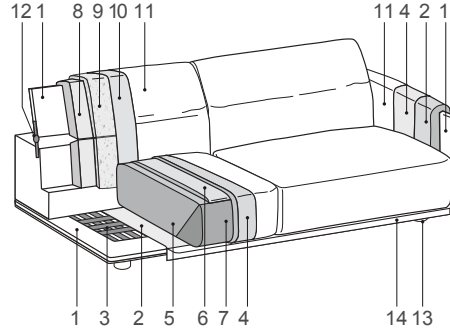

- 1. Wooden structure
- 3. Springing
- 2,4,5,6,7,8,9,10. Padding
- 11. Upholstery
- 12. Headrest mechanism
- 13. Feet
- 14. Frontal bar

#### Seat

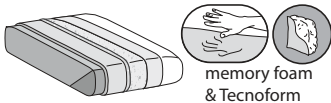

D.35/40kg/m<sup>3</sup>

#### Backrest

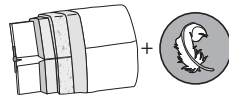

D.21kg/m<sup>3</sup>

#### Structure

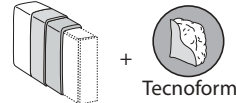

Polyurethane foam



ECOSY padding in recycled polyester fibers is an alternative to down padding. Available on demand without surcharge.

#### Feet

Standard Tail  
(HIGH)



5"1/8

Standard  
(LOW)



1"5/8H

\* For more specifications, please refer to the "Finishes & Materials" PDF

## Kris

---

### *Decorative cushions* (feather padding)

- 1: 21"5/8W x 5"7/8D x 21"5/8H
- 2: 17"3/4W x 5"7/8D x 17"3/4H
- 3: 17"3/4W x 5"7/8D x 13"3/4H
- 4: 19"5/8W x 5"7/8D x 19"5/8H
- 5: 17"3/4W x 5"7/8D x 14"1/8H
- 6: 18"7/8W x 5"7/8D x 18"7/8H
- 7: 23"5/8W x 5"7/8D x 11"7/8H
- 8: 23"5/8W x 5"7/8D x 23"5/8H
- 9: Ø19"5/8 x 5"7/8D

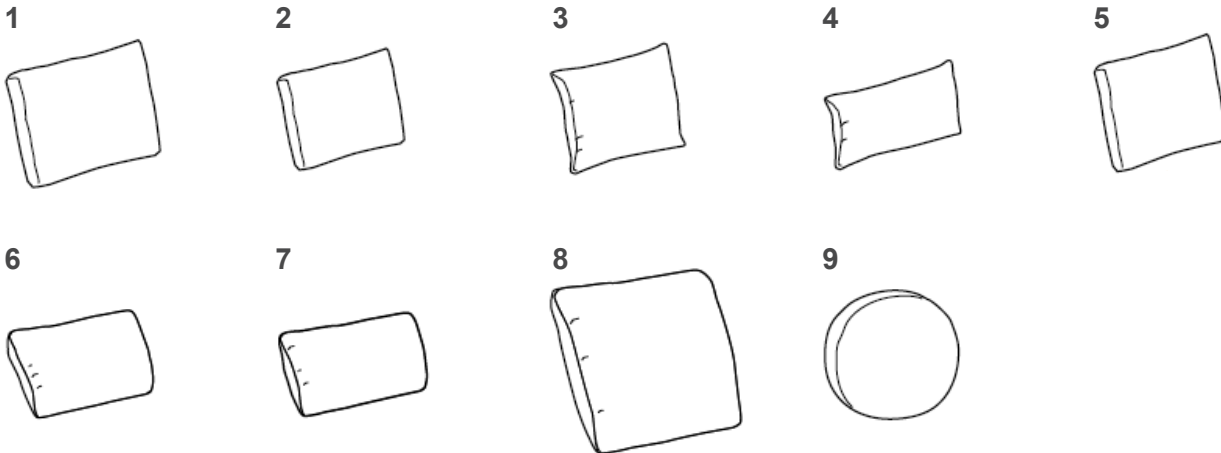

\* For more specifications, please refer to the "Finishes & Materials" PDF