

Lars

Design: Giuseppe Viganò



Description

Sectional that features big cushions and conveys a sense of comfort and relaxation. The armrests are inclined outwardly; the upholstery, available in fabric or leather, is fully removable. The metal base, consisting of slender linear feet or a shaped base, guarantees a suspended look.

Also, Lars square ottoman and decorative cushions, are available upon request. Back cushions are included. This exclusive sectional, allow maximum modularity, thanks to the numerous elements which make it possible to create different innovative solutions. Made in Italy.

With feet

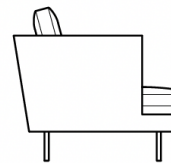

With shaped base

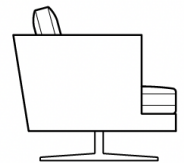

Lars

Dimensions

C1) 130"W x 90"1/2D x 34"5/8H

C2) 139"3/8W x 67"D x 34"5/8H

C3) 115"3/4W x 67"D x 34"5/8H

C4) 151"1/8W x 67"D + 37"3/8D x 34"5/8H

C5) 141"3/4W x 90"1/2D x 34"5/8H

C6) 105"1/8W x 105"1/8D x 34"5/8H

Seat height: 17" | Armrest height: 28"3/4

Composition 1

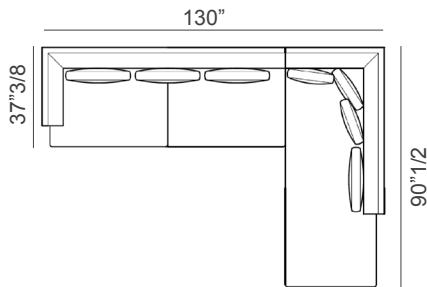

Composition 2

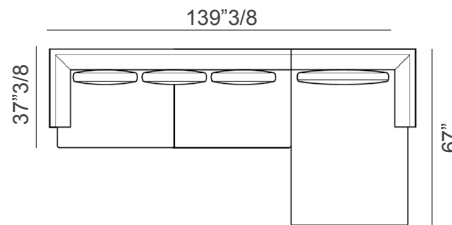

Composition 3

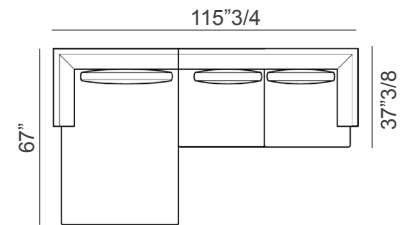

Composition 4

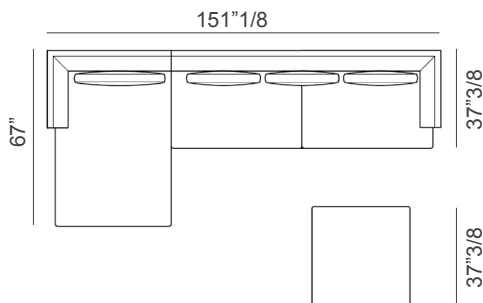

Composition 5

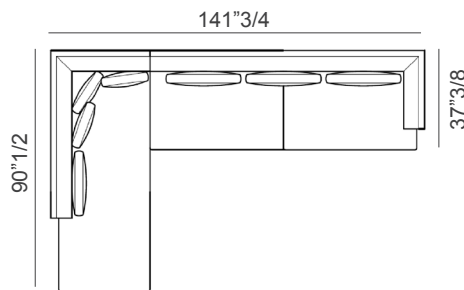

Composition 6

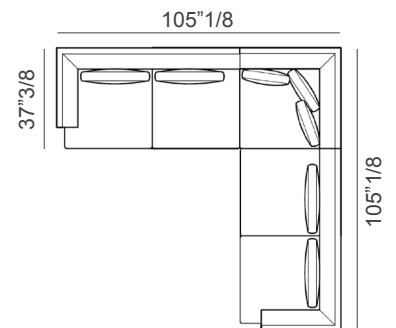

Optionals

Lars ottoman:

37"3/8W x 37"3/8D x 17"H

