

Soho

Design: Carlo Colombo



Description

Sectional with internal structure in multilayer wood for the backrests and armrests, and an iron tube for the bases, covered with polyurethane foam in different densities and polyester fibers. Seat cushions in polyurethane foam, covered in polyester fibers. Each seat is equipped with elastic bands to increase comfort. Backrest cushions in goose down with internal support in polyurethane foam. Feet in painted metal with a solid pau ferro wood end. Removable covers available in fabric or leather. The modules are available in two depths that can be combined together. Can be equipped with integrated small tables available in Antology inlay and ash wood. A cushion is included for each element of the sofa with backrest. Thanks to its modular nature, makes all kinds of customization possible. Made in Italy.



* For more specifications, please refer to the "Finishes & Materials" PDF

Soho

Suggested compositions

Composition 1

119"1/4W x 41"3/8D x 28"H

Seat height: 17"

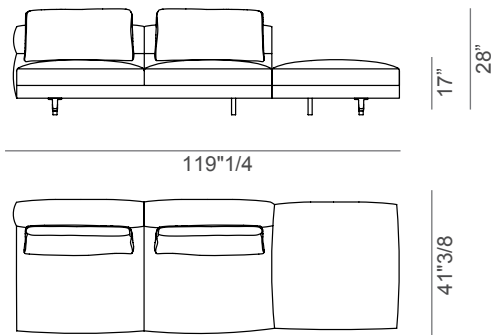

Composition 2

128"3/8W x 41"3/8D x 28"H

Seat height: 17"

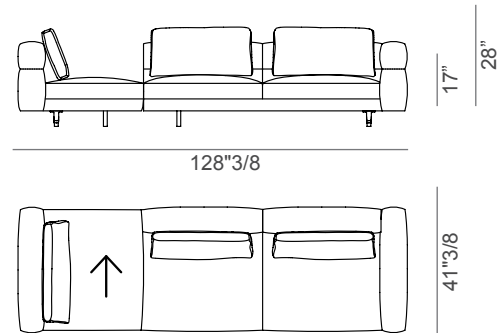

Composition 3

134"1/4W x 65"D x 28"H

Seat height: 17"

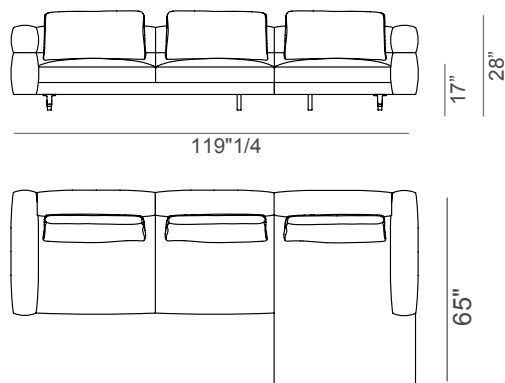

Composition 4

158"5/8W x 49"1/4D x 28"H

Seat height: 17"

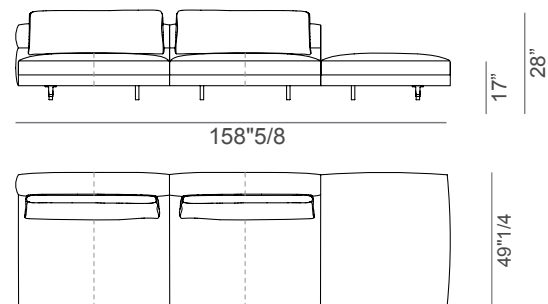

* For more specifications, please refer to the "Finishes & Materials" PDF

Soho

Composition 5

165"3/4W x 41"3/8D x 28"H

Seat height: 17"

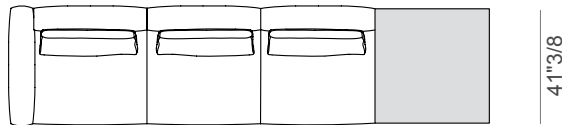
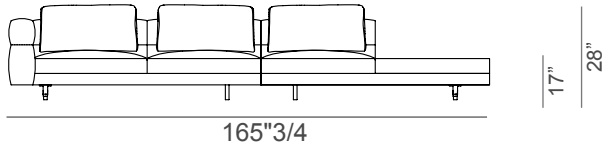

Composition 7

165"3/4W x 65"D x 28"H

Seat height: 17"

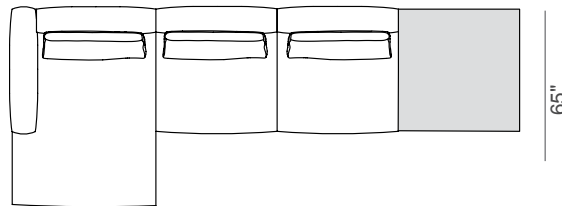
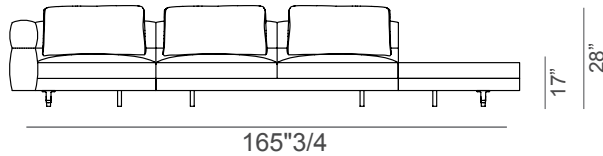

Composition 6

165"3/4W x 65"D x 28"H

Seat height: 17"

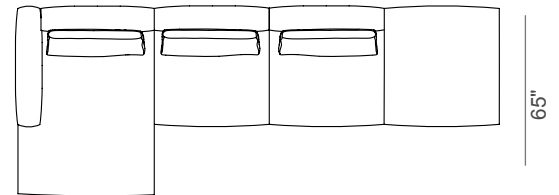
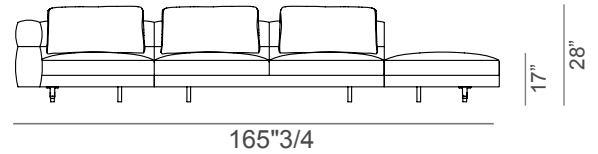

Composition 8

174"W x 65"D x 28"H

Seat height: 17"

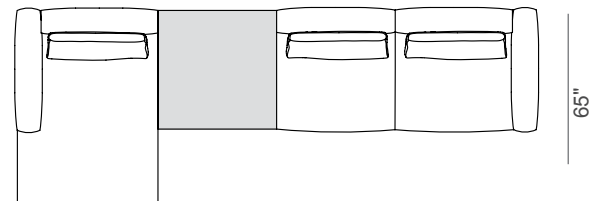
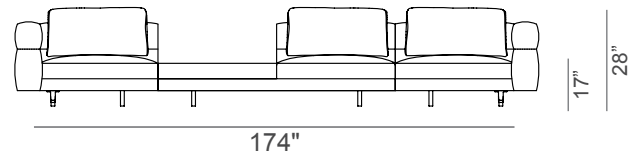

Decorative cushions:

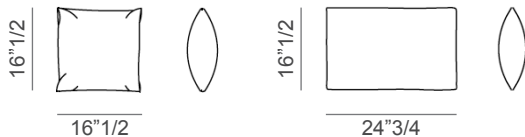
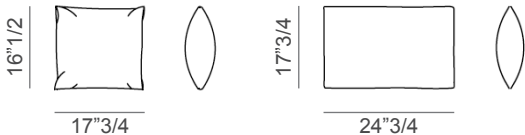

Finishes & Materials

Feet: Metal and Wood.

Covers: Fabric or Leather.

Low Table: Wood

* For more specifications, please refer to the "Finishes & Materials" PDF