

## Belt Air

*Design: Daniele Lo Scalzo Moscheri*



### *Description*

Sectional with piping in the same fabrics as the back/lower part of the element. This collection is characterized by the possibility to create multiple combinations\*.

Made in Italy.

\*The size of the compositions could vary by a few centimeters compared to the dimensions indicated, due to the padding that don't allow for precise volumes. For all the compositions proposed, the hardware to link the modules is included.

Composition A:  
177"1/8W x 70"7/8D x 27"1/2H

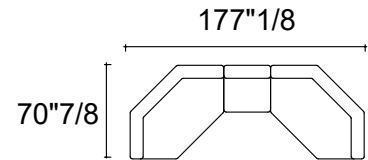
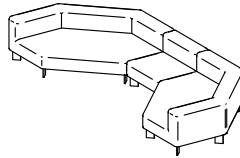

Composition B:  
165"3/8W x 82"5/8D x 27"1/2H

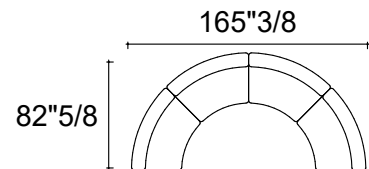
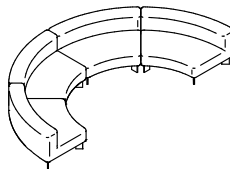

Composition C:  
145"5/8W x 56"1/4D x 27"1/2H

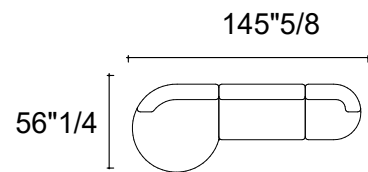
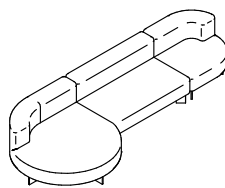

Composition D:  
204"3/4W x 70"7/8D x 27"1/2H

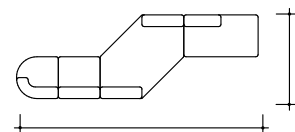
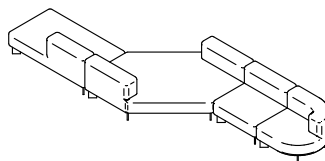

Composition E:  
283"3/8W x 196"7/8D x 27"1/2H

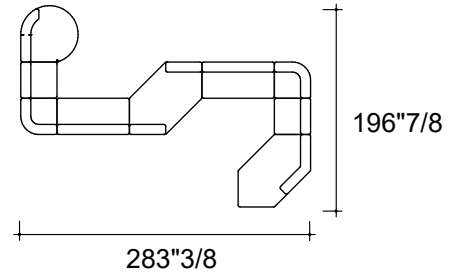
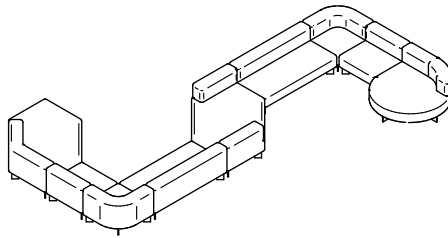

Composition F:  
204"3/4W x 177"1/8D x 27"1/2H

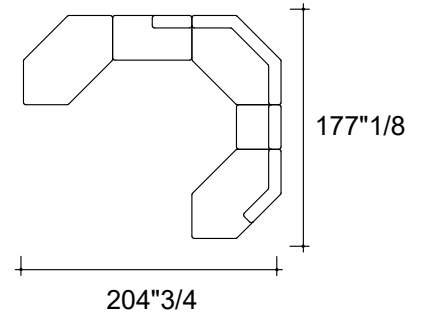
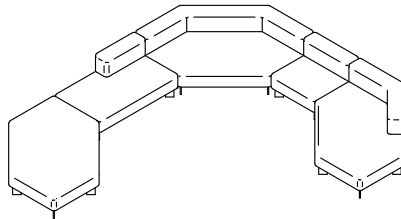

Composition G:  
189"W x 173"1/4D x 27"1/2H

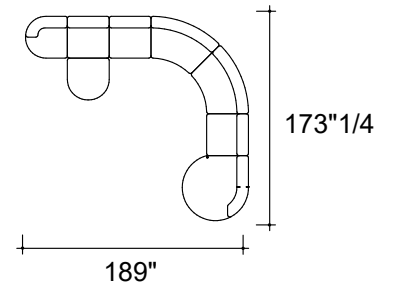
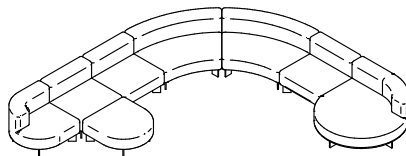

Composition H:  
259"7/8W x 200"7/8D x 27"1/2H

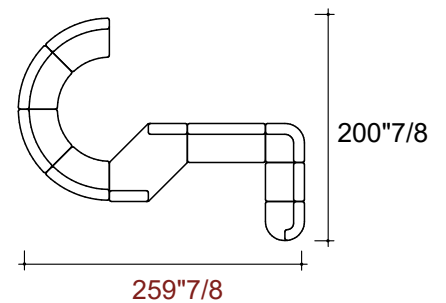
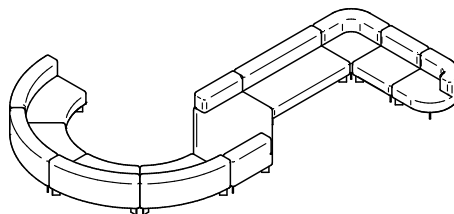

Composition I:

354"3/8W x 133"7/8D x 27"1/2H

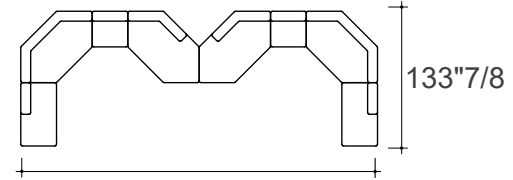
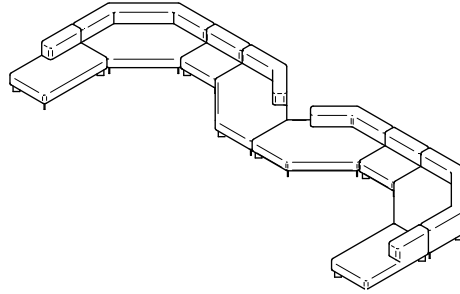

354"3/8

133"7/8