

# Atlantis

*Design: Gabriele & Oscar Buratti*



## *Description*

A refined modular system to furnish a welcoming place, built around individual needs and desires. Unprecedented tilt angles and variable depth of elements, together with an armrest which acts as a coffee table or a cushion make Atlantis a flexible and functional sofa.

## Atlantis

---

### *Dimensions*

**Comp. A:** 199"5/8W x 130"5/8D x 33"7/8H

**Left**

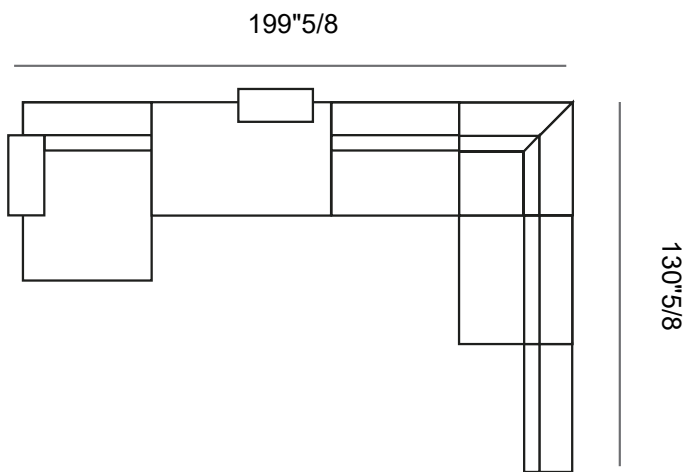

**Right**

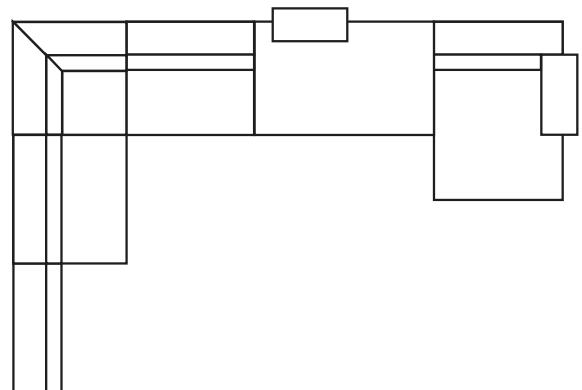

## Atlantis

---

### *Dimensions*

**Comp. B:** 154"3/4W x 74"D x 33"7/8H

**Left**

154"3/4

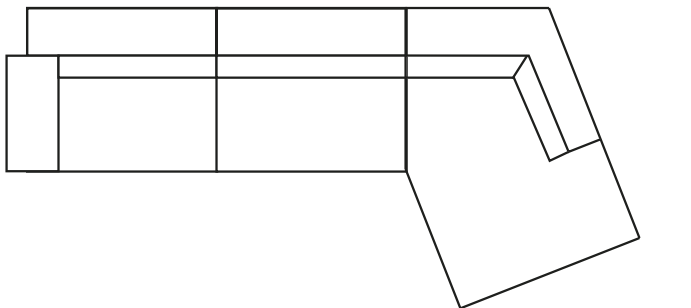

74"

**Right**

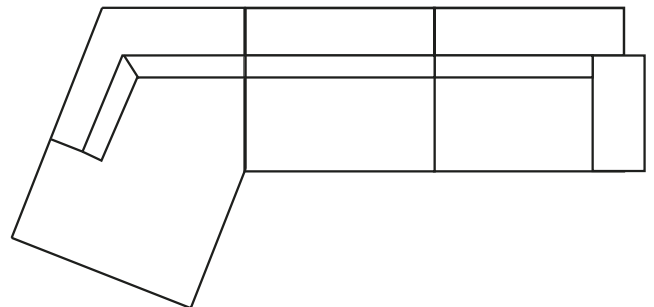

## Atlantis

---

### *Dimensions*

**Comp. C:** 147"1/4W x 62"1/8D x 33"7/8H

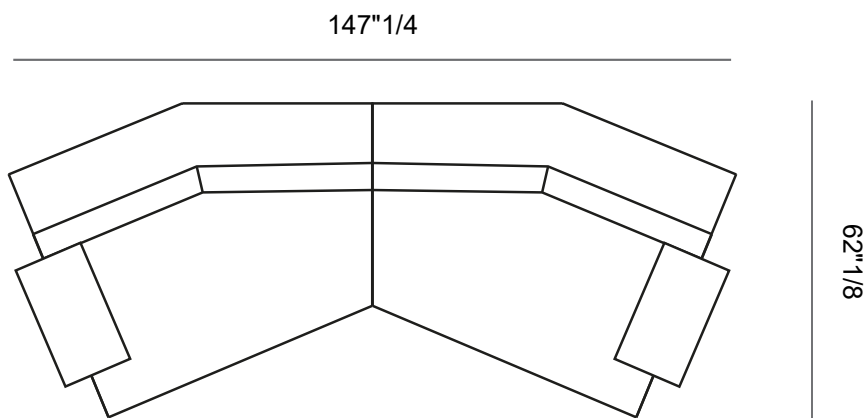

## Atlantis

---

### *Dimensions*

Comp. D: 193"1/4W x 142"1/2D x 33"7/8H

Left

193"1/4

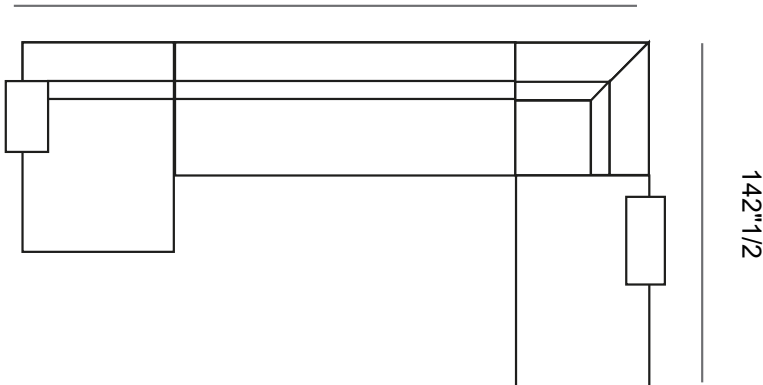

Right

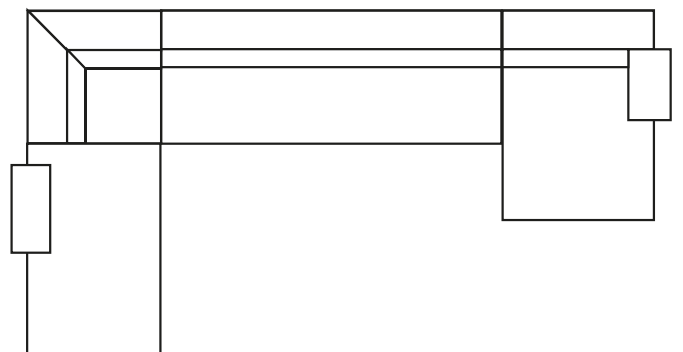

## Atlantis

---

### *Dimensions*

Comp. E: 187"W x 62"1/4"D x 33"7/8"H

Left

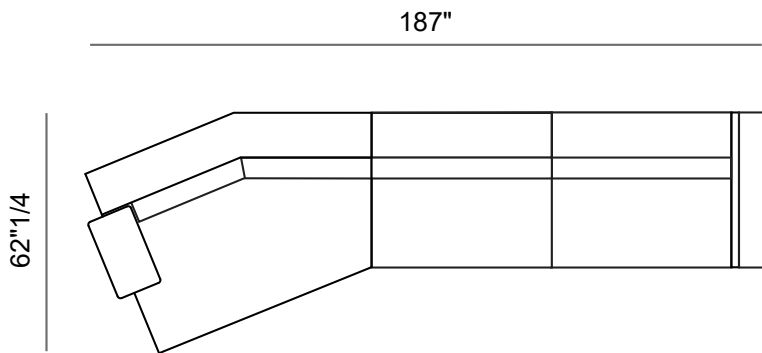

Right

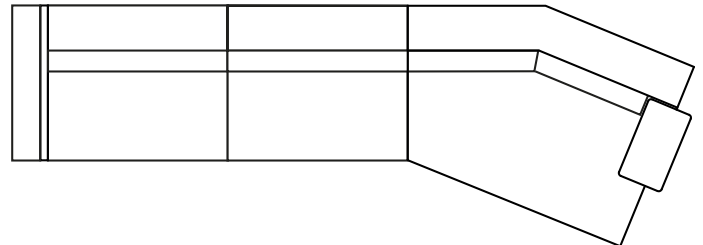

## Atlantis

---

### *Dimensions*

**Comp. F:** 146"7/8W x 63"3/4D x 33"7/8H

**Left**

146"7/8

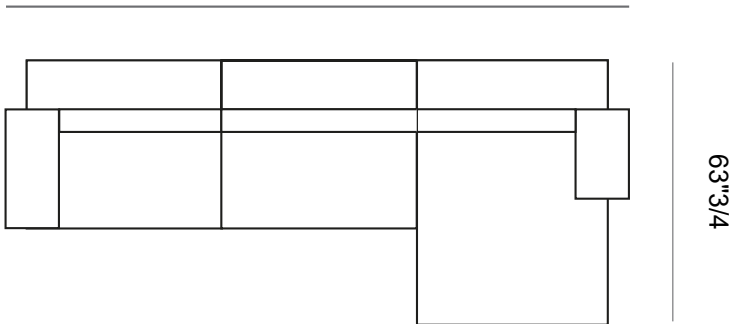

**Right**

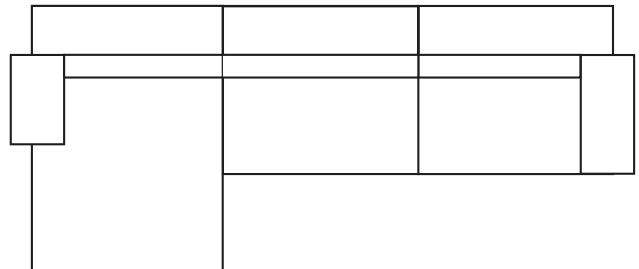

## Atlantis

---

### *Dimensions*

Comp. G: 157"1/2W x 63"3/4D x 33"7/8H

**Left**

157"1/2

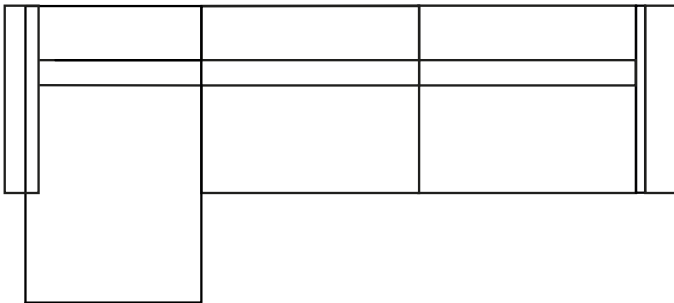

63"3/4

**Right**

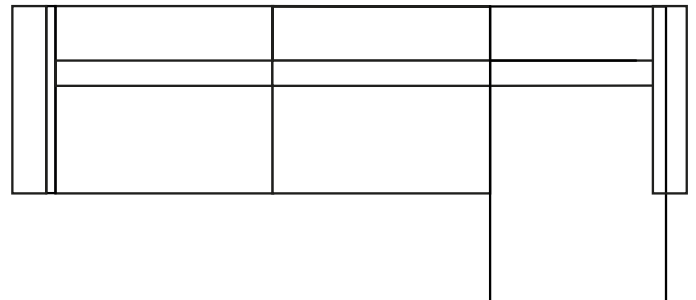

## Atlantis

### Decorative cushions (feather padding)

- 1: 21"5/8W x 5"7/8D x 21"5/8H
- 2: 17"3/4W x 5"7/8D x 17"3/4H
- 3: 17"3/4W x 5"7/8D x 13"3/4H
- 4: 19"5/8W x 5"7/8D x 19"5/8H
- 5: 17"3/4W x 5"7/8D x 14"1/8H
- 6: 18"7/8W x 5"7/8D x 18"7/8H
- 7: 23"5/8W x 5"7/8D x 11"7/8H
- 8: 23"5/8W x 5"7/8D x 23"5/8H
- 9: Ø19"5/8 x 5"7/8D

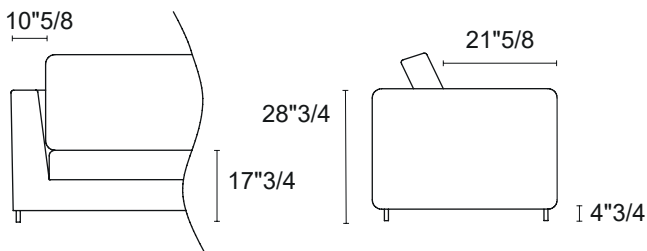
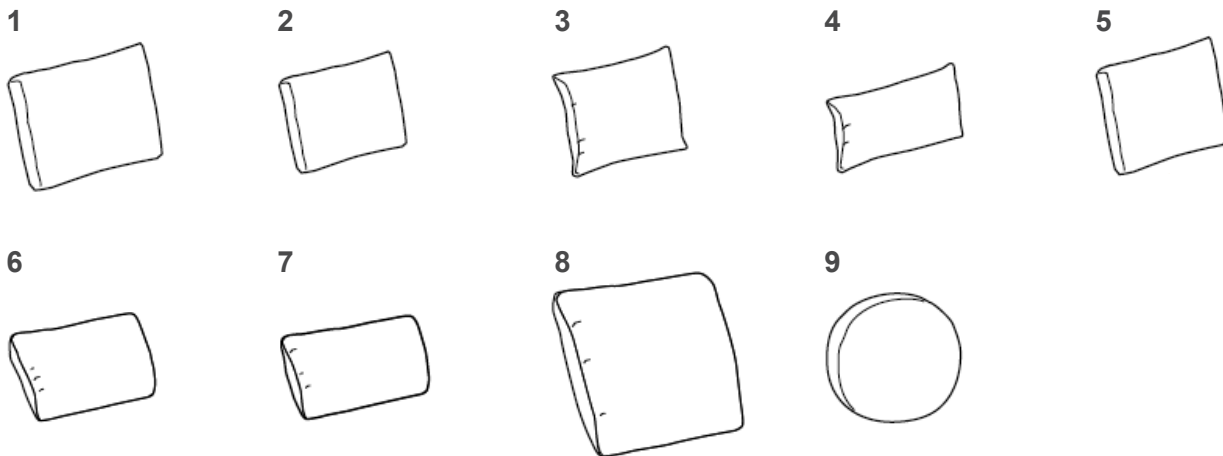

### Feet

