

Air

Design: Daniele Lago



Description

Blocks and voids take turns to give shape to a modern and stylish sideboard.

The Air system has expanded to include this elegant sideboard that plays on the contrast between solids and voids, inverting the order of factors: the piece seems to float in air, supported by transparent tempered glass sheets to create a surprising effect of suspension.

The innovative XGlass technology combines the elegance of glass with the magic of elements such as marble, metal, wood and fabrics, affording mesmerizing textured effects.

A storage solution with minimal and elegant lines, it fits into interiors with a refined character which comes in two different versions, one with tempered-glass legs extremely resistant to knocks.

Available optional accessories: glass top, back and bottom LED light.

Made in Italy.

Finishes & Materials

Fronts: Lacquered, Polished and Matt Glass or XGlass.

Structure: Lacquered.

Supports: Tempered Glass.

Air

Dimensions

- A) 43"3/8W x 16"D x 29"5/8H
- B) 58"W x 16"D x 29"5/8H
- C) 72"3/8W x 16"D x 29"5/8H
- D) 58"W x 16"D x 39"7/8H
- E) 72"3/8W x 16"D x 39"7/8H
- F) 58"W x 20"D x 39"7/8H
- G) 72"3/8W x 20"D x 39"7/8H

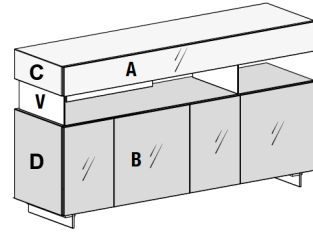
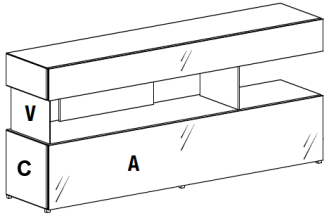

Version 1

- A) Lacquered, Polished/Matt Glass or XGlass.
- C) Lacquered.
- V) Tempered Glass.

Version 2

- A-B) Lacquered, Polished/Matt Glass.
- C) Lacquered.
- V) Tempered Glass.

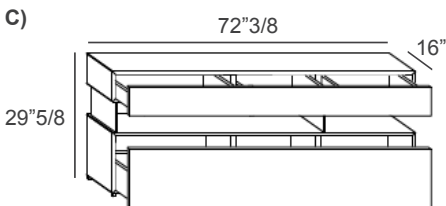
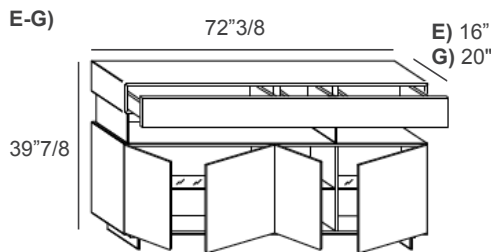
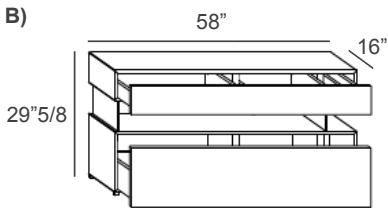
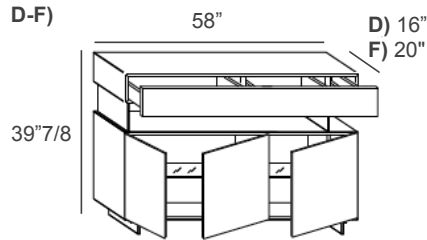
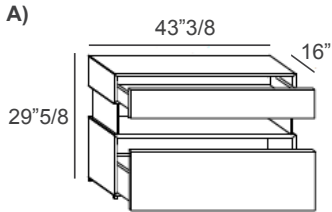

Optional accessories

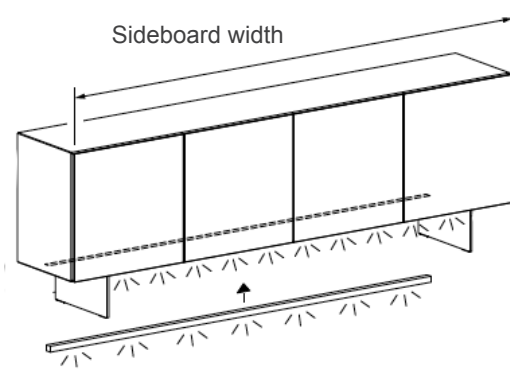

Optional back LED lighting

Horizontal sideboard-width strip.
300K000°K - Clip fastening.
Control with wall switch.
With or without power unit
(80 W - 110V - At least one light required
-Not set up for cables to pass through).
Available only for Version 2.

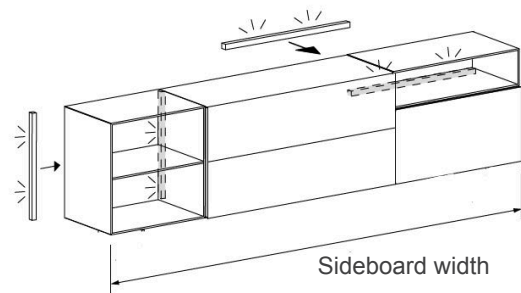

Optional back LED lighting

Horizontal or vertical small strip.
3000°K - Clip fastening.
Control with wall switch.
With or without power unit
(80 W - 110V - At least one light required -
Not set up for cables to pass through).
With or without dimmer remote.

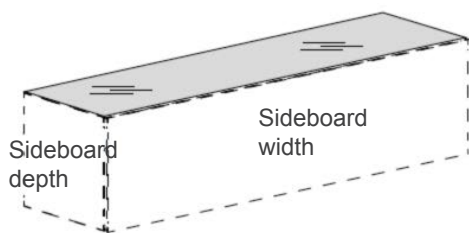

Optional glass top

Sideboard-width & sideboard-depth.
1/8" thick.

