

Brunch

Design: Romano Marcato



Description

Desk with top in curved honeycomb board with variation in thickness, internal frame in plywood of poplar and beech, and veneered in several finishes, white laminate, white Fenix® or white lacquered. Base in matt chromed metal or powder coated, with adjustable feet for a better stability.

Asymmetry and versatility are the distinguishing features of the Brunch collection of modular tables. This desk is composed of a wooden top that curves down to the ground and gently changes thickness and a metal base available in powder coated black or white. Of great originality Brunch desk is ideal for the office or as a workstation in public spaces. Made in Italy.

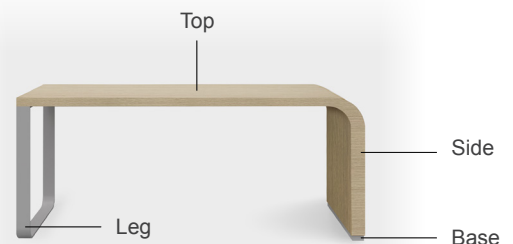

Brunch

Dimensions

Size A: 55"1/8W x 27"1/2D x 29"1/8H

Size B: 70"7/8W x 27"1/2D x 29"1/8H

Size C: 55"1/8W x 27"1/2D x 35"3/8H

Size D: 70"7/8W x 27"1/2D x 35"3/8H

Size E: 55"1/8W x 27"1/2D x 43"1/4H

Size F: 70"7/8W x 27"1/2D x 43"1/4H

Size A-B

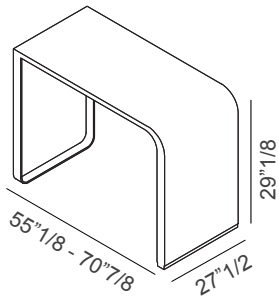

Size C-D-E-F

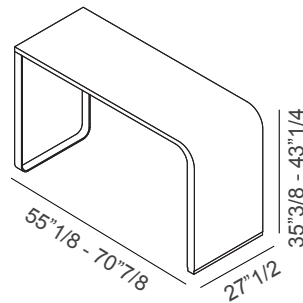

Leg

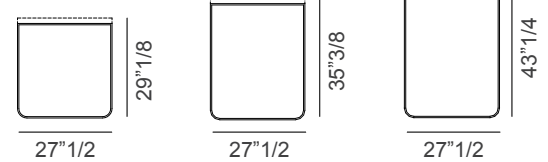

Top, Side & Base

Size A

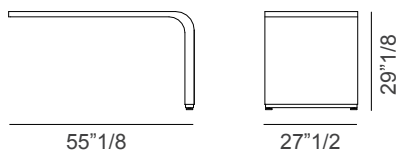

Size B

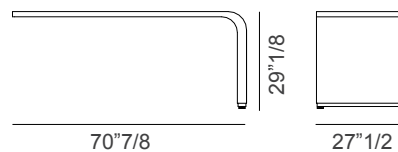

Size C

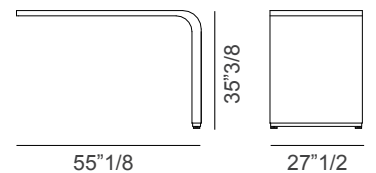

Size D

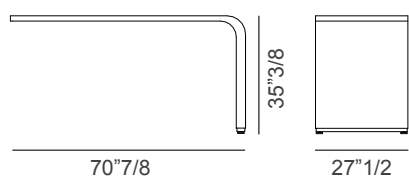

Size E

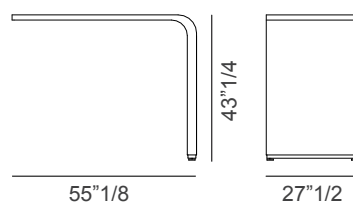

Size F

