

Kenobi

Design: Marco Acerbis



Description

Dining table with 4 legs available in solid walnut or wood with leather applications. Round top available in marble (Onyx on request) or MDF walnut veneer. Top edge in MDF with leather applications. Also available with legs in solid beech with glossy monochrome polyester lacquer finish, and top and top edge in MDF with glossy monochrome polyester lacquer finish. Metal details in top edge and legs. Lazy Susan available. Made in Italy.



Kenobi

Dimensions

A: Ø63" x 29"1/2H

B: Ø70"7/8 x 29"1/2H

A

*Legs & top edge in leather
Top in walnut wood or marble*

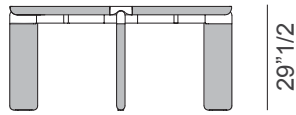

Ø63

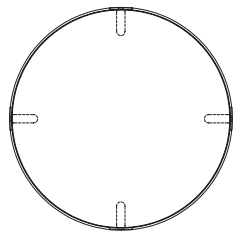

Legs & top in lacquered wood

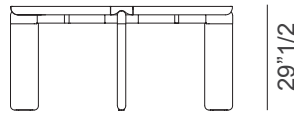

Ø63

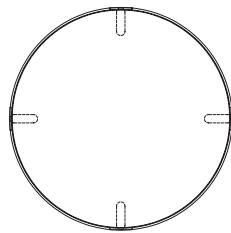

*Legs in walnut wood, top edge in leather
Top in walnut wood or marble*

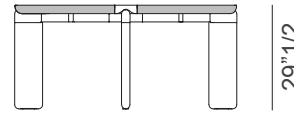

Ø63

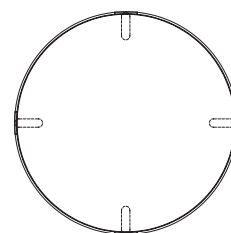

B

*Legs & top edge in leather
Top in walnut wood or marble*

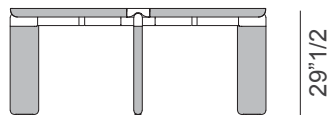

Ø70"7/8

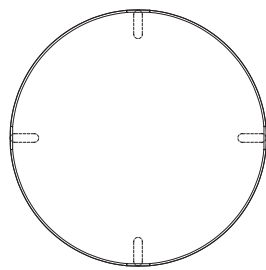

Legs & top in lacquered wood

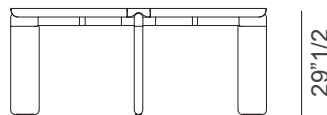

Ø70"7/8

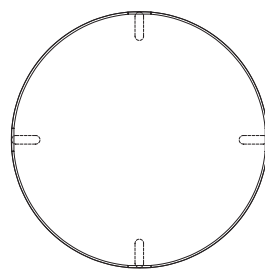

*Legs in walnut wood, top edge in leather
Top in walnut wood or marble*

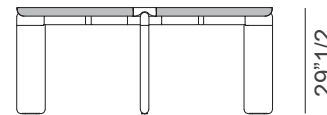

Ø70"7/8

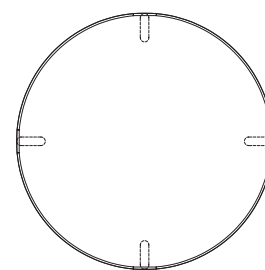

Kenobi

Example compositions

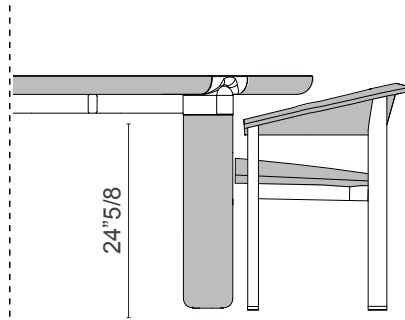

KENOBI table Ø63" and LYNN armchairs

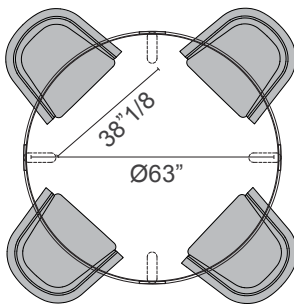

KENOBI table Ø70 7/8" and LYNN armchairs

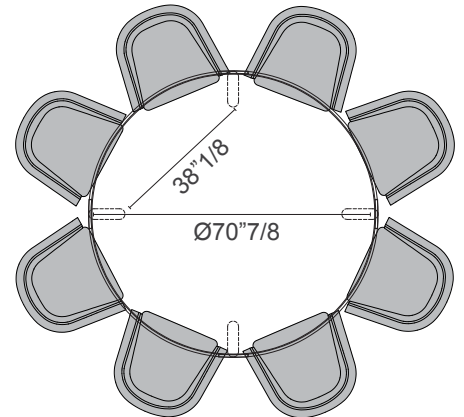
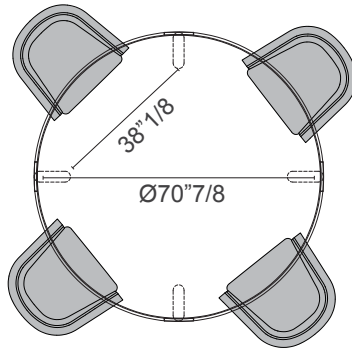

Lazy Susan

