

Roger

Design: Marconato & Zappa



Description

The Roger is engineered with a robust frame of fir wood and engineered panels, supported by a high-performance Intes Elasebelt 3"3/8 (90mm) suspension system. The structure is padded with differentiated density polyurethane foam (T30 N and T75) and coupled resin. For the ultimate seating experience, the padding has two options: polyurethane or ORO goose down padding for the seat and back cushions, both featuring specialized density inserts (SH 30, T21 SS, and Eucalipto) for superior ergonomic recovery. The unit is anchored by aluminum feet available in polished, satin, or painted finishes, and features a completely removable cover in a curated selection of fabrics and leathers.

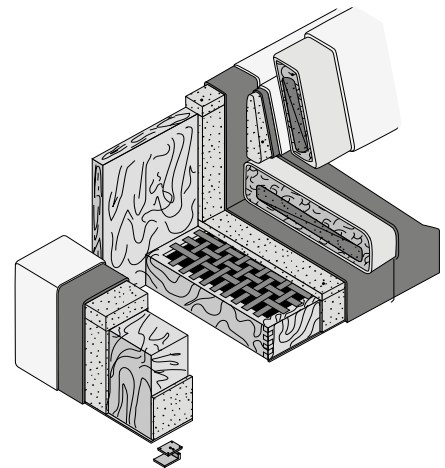

Roger

Dimensions

A: 66"1/2W x 41"3/4D x 33"1/2H

B: 74"3/8W x 41"3/4D x 33"1/2H

C: 82"1/4W x 41"3/4D x 33"1/2H

D: 90"1/8W x 41"3/4D x 33"1/2H

E: 98"W x 41"3/4D x 33"1/2H

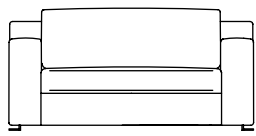

66"1/2

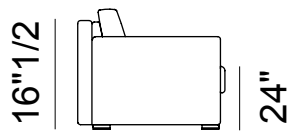

66"1/2

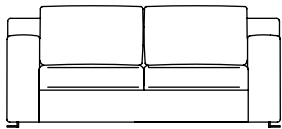

74"3/8

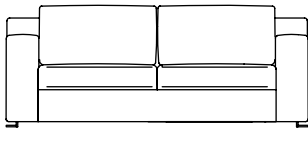

82"1/4

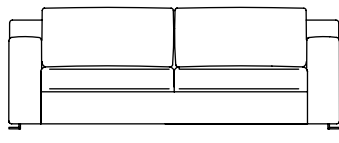

90"1/8

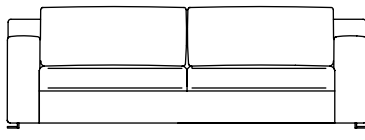

98"