

EYBA 02

Design: Norah Creative Lab FM



Description

The EYBA 02 modern oval countertop washbasin by Norah Design is an elegant study in fluid geometry and functional luxury. Designed to serve as a sculptural centerpiece, its elongated silhouette offers a soft, organic aesthetic that contrasts beautifully with the architectural lines of a contemporary vanity. This basin transforms the bathroom into a refined wellness sanctuary, balancing a generous wash area with a slim, sophisticated profile.

Finishes & Materials

Washbasin: Crystal.

Cover drain: Acrylic.

Cabinet: Lacquer or wood.

EYBA 02

Dimensions

1 Washbasin: 21"5/8W x 15"3/4D x 7"H

Wooden cabinet with open space + 1 washbasin: 47"1/4W x 20"7/8D x 22"7/8H

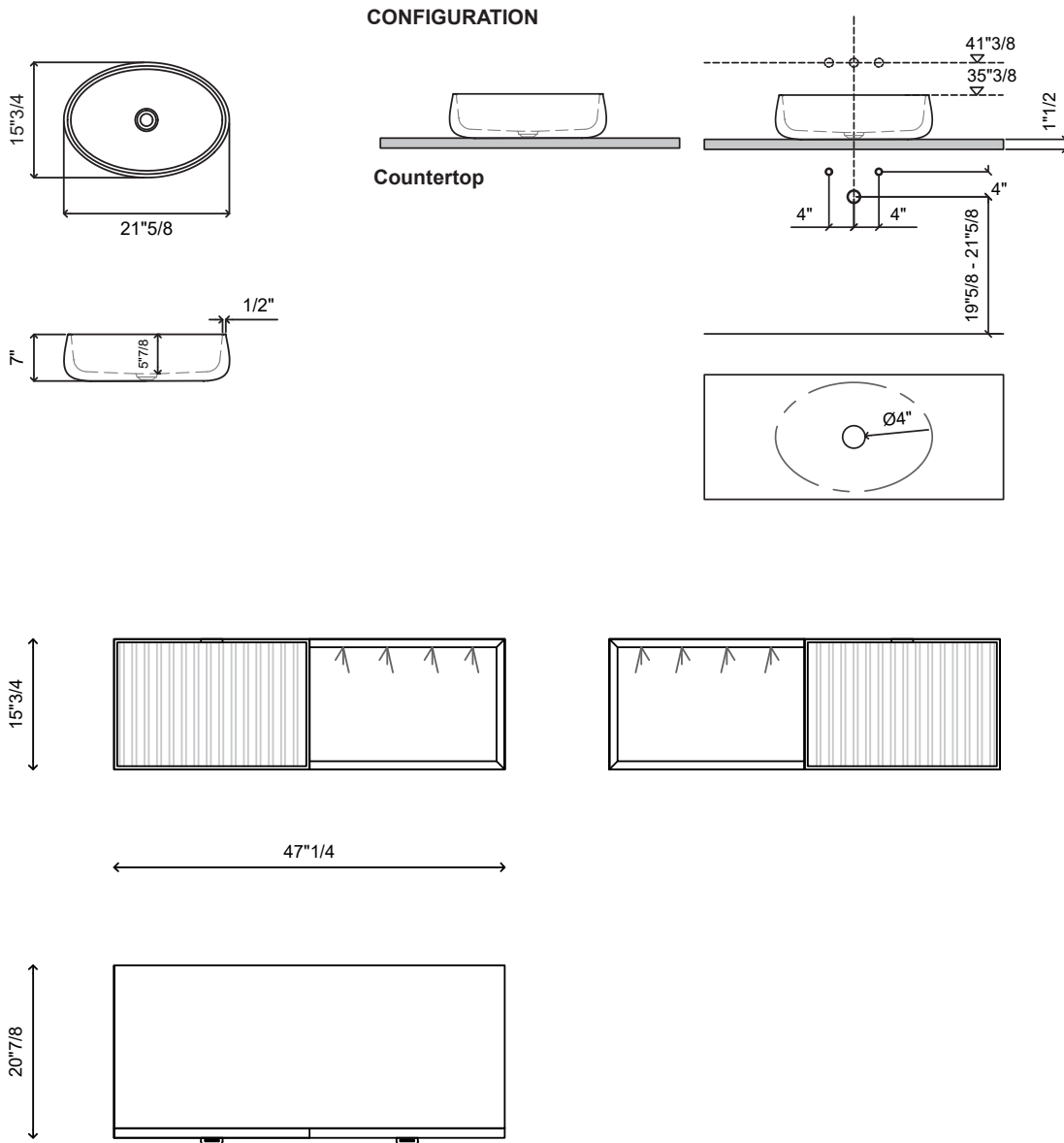

EYBA 02

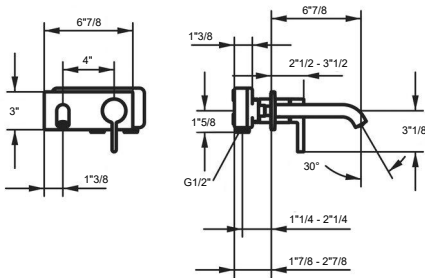
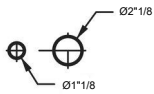

- * Trim kit Lever mixer
- * EcoProtect - water-saving device
- * Fixed spout
- Neoperl® Caché® CS, Coin Slot
- * OptimalSpace - ample space for washing or working
- * KWC cartridge M 35 H

- with ceramic discs
- flow rate and temperature continuously variable
- * To be ordered separately:
- Unit for concealed installation 1/2" 39.001.401.931
- * To be ordered separately (optional or if necessary):
- Extension set 20 mm Z.536.333

Technical Data

Flow rate	5 l/min (3 bar)
Spout	fixed
Diameter	173 x 74
Handling	front lever
Color code	chrome
Installation_type	Wall mounted
Faucet_typ	Lever mixer
G_Acoustic group	I
Concealed_unit	Trim kit
Projection_A	A 225
Energy Label	A
material	Brass

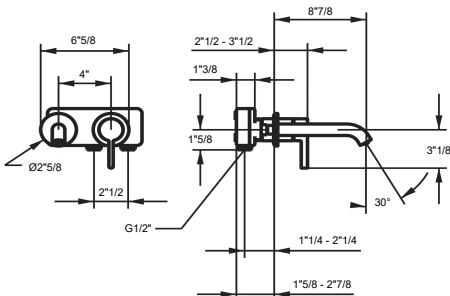
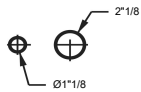

- * Trim kit Lever mixer
- * EcoProtect - water-saving device
- * Fixed spout
- Neoperl® Caché® CS, Coin Slot
- * OptimalSpace - ample space for washing or working
- * KWC cartridge M 35 H

- with ceramic discs
- flow rate and temperature continuously variable
- * To be ordered separately:
- Unit for concealed installation 1/2" 39.001.401.931
- * To be ordered separately (optional or if necessary):
- Extension set 20 mm Z.536.333

Technical Data

A_Spout_Spray	5 l/min (3 bar)
Connection	G 1/2"
Spout	fixe
Diameter	168 x 68
Handling	front lever
Color_code	chromeline
Installation_type	Wall mounted
Faucet_typ	Lever mixer
G_Acoustic group	I
Concealed_unit	Trim kit
Projection_A	A 225
Energy Label (CH)	A
Connection measure	Range CH curent
material	Brass

EYBA 02

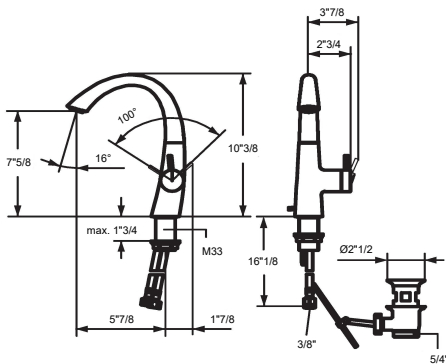

- * Lever mixer
- * Lever installation only possible on the right side
- Child safety: cold water flow in lever position towards the front
- * gap between wall and centre of mounting hole min. 45 mm
- * EcoProtect - water-saving device
- * Swivel spout 90°
- Neoperf® Caché®

- * OptimalSpace - ample space for washing or working
- * KWC cartridge S 25
- with ceramic discs
- flow rate and temperature continuously variable
- * Flexible connection hoses 3/8"
- * Fastening by means of threaded sleeve M33 x 1.5
- * Mounting hole size ø35 mm

Technical Data

Flow rate	6 l/min (3 bar)
Pop-up_valve	without pop-up valve
Connection	Flexible connection hoses
Spout	swivel
Handling	side lever
Color code	chrome
Installation_type	Pillar installation
Faucet_typ	Lever mixer
Dimension Height	262
G_Acoustic group	I
Projection_A	A 150
Energy Label	A
Dimension Water outlet	195
material	Brass

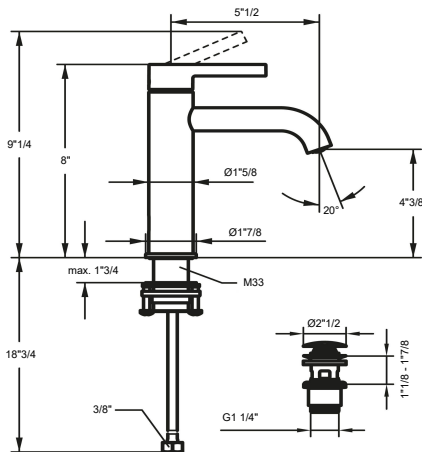

- * Lever mixer
- * EcoProtect - water-saving device
- * Fixed spout
- Neoperf® Caché® CS Coin Slot
- * OptimalSpace - ample space for washing or working
- * KWC cartridge M 35 OP
- with ceramic discs
- flow rate and temperature continuously variable

- temperature limitation
- * Flexible connection hoses 3/8"
- * QuickInstallation - Fastening via threaded connection with locking screws
- * Mounting hole size ø35 mm
- * Scope of delivery:
- KWC pop-up valve Push Open 2 in 1 Z.540.049.700

Technical Data

A_Spout_Spray	5 l/min (3 bar)
Pop-up_valve	MIT PUSH_OPEN
Connection	Flexible connection hoses
Spout	fixe
Handling	top lever
Color code	brushed steel
Installation_type	Pillar installation
Faucet_typ	Lever mixer
Measure_Height	201
G_Acoustic group	I
Projection_A	A 140
Energy Label (CH)	A
Dimension Water outlet	112
material	Brass