

Apsara

Design: Ludovica + Roberto Palomba



Description

Modular lounge chair with base in protected aluminum, powder painted in carob color, made up of Afrormosia wooden slats, alternated with others in aluminum. The upholstery is completely removable, with piping in waterproof outdoor technical fabric.

Apsara is a modular seating system made up of bases in two depths: a more classic and an extra-large one, for those who prefer more comfortable and soft forms. The padded parts (backrest and armrest cushions), but also the small tables, can be fixed to the aluminum slats of the base thanks to stainless steel pins. The backrest and the armrests are therefore removable and can be fixed along the axis of the slats, allowing to change the depth of the seat. The seat cushion can be freely positioned on the base, with no need to fix it. The bases can be fixed and aligned with each other by means of clips to be hooked, only horizontally, to the slats. Decorative cushions available on demand. Made in Italy.



Apsara

Dimensions

A: 48"W x 41"3/8D x 27"1/2H

B: 48"W x 48"D x 27"1/2H

A

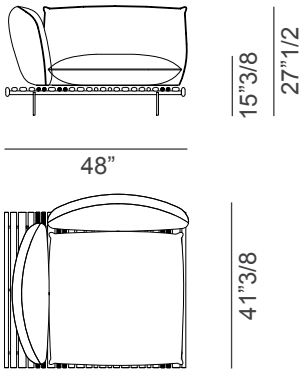

1x 88011 + 1x 88020 + 2x 88030

B

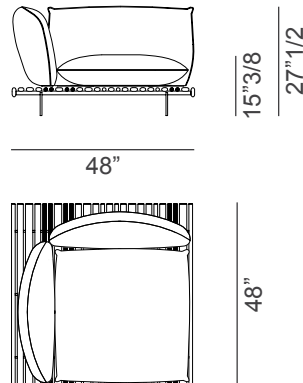

1x 88001 + 1x 88020 + 2x 88030

Apsara

Elements available

Base with slats in afrormosia and aluminum

88000

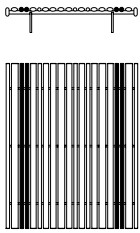

38"1/8W x 48"D x 7"1/2H

88011

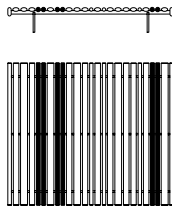

48"W x 41"3/8D x 7"1/2H

88001

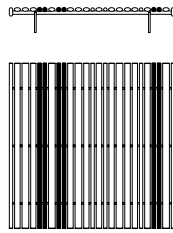

48"W x 48"D x 7"1/2H

88010

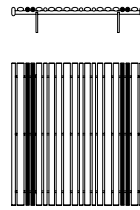

38"1/8W x 41"3/8D 7"1/2H

88015

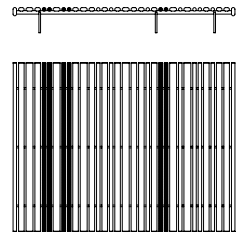

63"3/8W x 48"D x 7"1/2H

Seat cushion, piping in technical fabric

88021

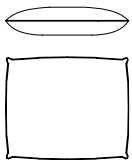

35"3/8W x 29"1/2D x 7"7/8H

88020

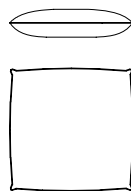

35"3/8W x 35"3/8D x 7"7/8H

Double seat cushion, piping in technical fabric

88022 For sofa

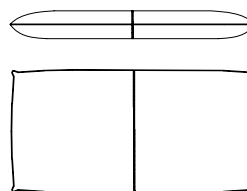

70"7/8W x 35"3/8D x 7"7/8H

88023 For chaise lounge

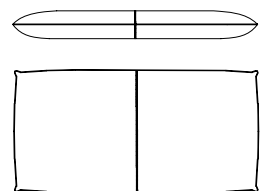

70"7/8W x 35"3/8D x 7"7/8H

Seat cushion for 88015, piping in technical fabric

88024

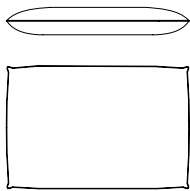

53"1/8W x 35"3/8D x 7"7/8H

Backrest cushion, piping in technical fabric

88030

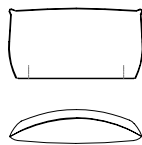

37"3/8W x 11"7/8D x 20"1/2H (both)

88033 Reclining

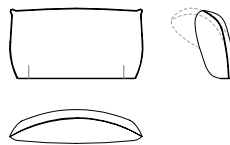

Armrest cushion, piping in technical fabric

88032 Short

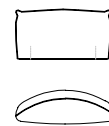

27"1/2 x 11"7/8D x 14"5/8H - Short
37"3/8W x 11"7/8D x 14"5/8H - Long

88031 Long

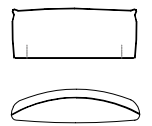

Decorative cushions

88040



23"5/8 x 18"1/2

88050



17"3/4 x 13"3/4

Apsara

Elements available

Side table with round Peltrox® top

88560

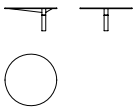

Ø15"3/4 x 7"1/2H

88561

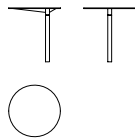

Ø15"3/4 x 12"1/8H

88562

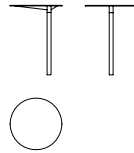

Ø15"3/4 x 17"H



Side table with square Peltrox® top

88565

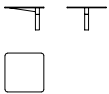

11"7/8W x 11"7/8D x 7"1/2H

88566

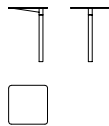

11"7/8W x 11"7/8D x 12"1/8H

88567

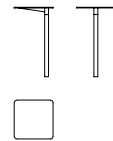

11"7/8W x 11"7/8D x 17"H

Side table with rectangular top in Etna lava stone

88570

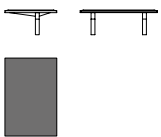

23"5/8W x 15"3/4D x 7"7/8H

88571

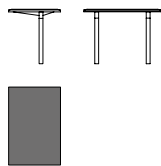

23"5/8W x 15"3/4D x 12"5/8H

88572

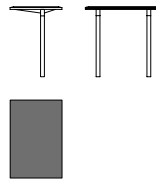

23"5/8W x 15"3/4D x 17"3/8H

Side table with rectangular top in Etna lava stone

88575

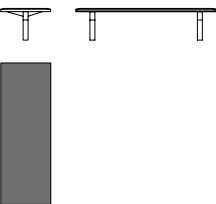

33"1/2W x 11"7/8D x 7"7/8H

88576

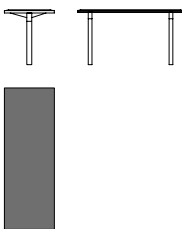

33"1/2W x 11"7/8D 12"5/8H

88577

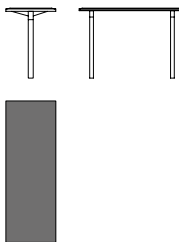

33"1/2W x 11"7/8D x 17"3/8H

