

## Artis

*Design: Stefano Spessotto & Lorella Agnoletto*



### *Description*

Ottoman with supporting structure in pinewood of various thicknesses. Remaining parts in E1 class particleboard panels. Details in hardboard or cellulose wood-based panels. The structure is completely covered with Tecnoform. The seat is supported by propylene and latex elastic belts. Padded structure with removable covers in fabric or non removable in eco-leather and leather. Seat cushion with removable covers in fabric, eco-leather and leather. Standard Bar feet, metal base or Team feet are available as an optional. "Punto Pettine" stitching is also available. Made in Italy.

### *Dimensions*

**A:** 31"1/2W x 31"1/2D x 16"1/2H  
**B:** 40"1/8W x 35"3/8D x 16"1/2H

**A**

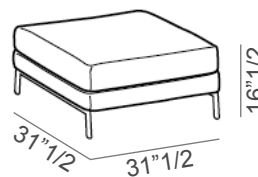

**B**

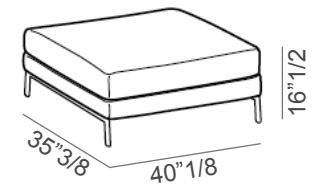

\* For more specifications, please refer to the "Finishes & Materials" PDF

## Artis

### Internal composition

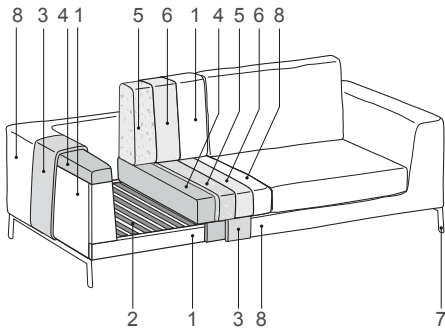

1. Wooden structure
2. Springing
- 3,4,5,6. Padding
7. Feet
8. Upholstery

### Seat

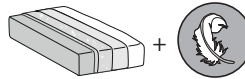

D.35kg/m<sup>3</sup>

### Backrest



Mixed feather

### Structure

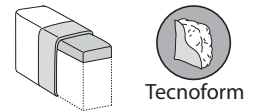

Tecnoform



ECOSY padding in recycled polyester fibers is an alternative to down padding. Available on demand without surcharge.

### Feet:

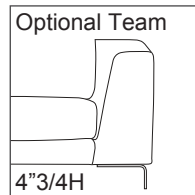
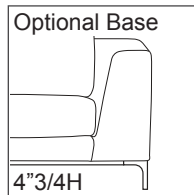
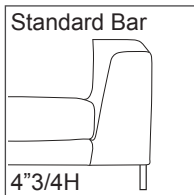

### Optional:

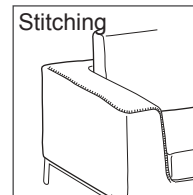

\* For more specifications, please refer to the "Finishes & Materials" PDF