

## Artis

*Design: Stefano Spessotto & Lorella Agnoletto*



### *Description*

Modular sofa with supporting structure in pinewood of various thicknesses. Remaining parts in E1 class particleboard panels. Details in hardboard or cellulose wood-based panels. The structure is completely covered with Tecnoform. The back is made of hard or cellulose wooden fiber panels. The seat is supported by propylene and latex elastic belts. Padded structure with removable covers in fabric or non removable in eco-leather and leather. Seat and backrest cushions with removable covers in fabric, eco-leather and leather. Standard Bar feet, metal base or Team feet are available as an optional. Metal top and box upholstered in recycled bonded leather. "Punto Pettine" stitching is also available. Made in Italy.



\* For more specifications, please refer to the "Finishes & Materials" PDF

## Artis

### Dimensions

- A: 122<sup>3</sup>/<sub>8</sub>W x 40<sup>1</sup>/<sub>8</sub>D x 31<sup>1</sup>/<sub>2</sub>H
- B: 138<sup>1</sup>/<sub>8</sub>W x 40<sup>1</sup>/<sub>8</sub>D x 31<sup>1</sup>/<sub>2</sub>H
- C: 154<sup>1</sup>/<sub>8</sub>W x 40<sup>1</sup>/<sub>8</sub>D x 31<sup>1</sup>/<sub>2</sub>H
- D: 169<sup>5</sup>/<sub>8</sub>W x 40<sup>1</sup>/<sub>8</sub>D x 31<sup>1</sup>/<sub>2</sub>H

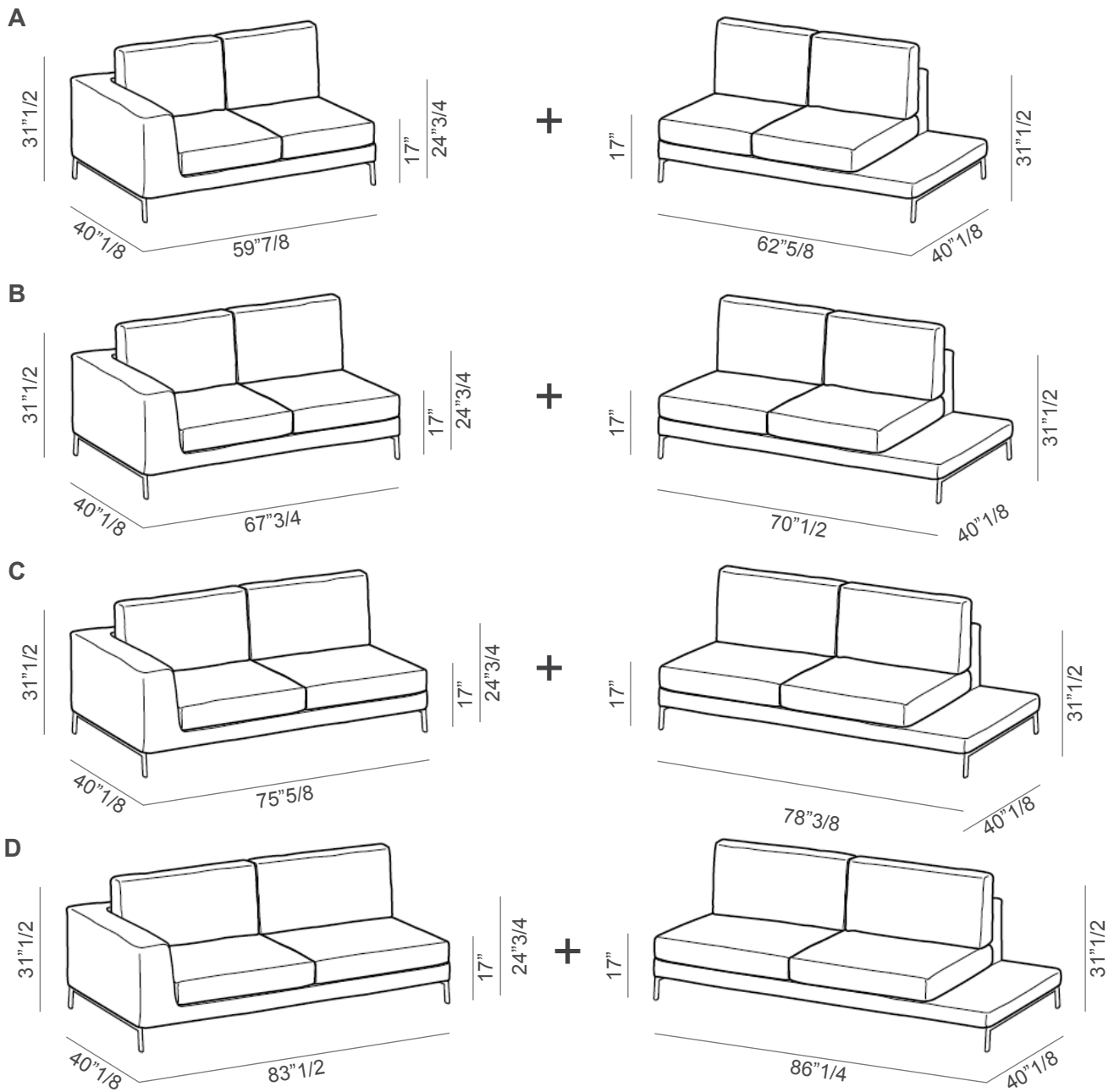

## Artis

### Dimensions

**E:** 119"5/8W x 40"1/8D x 31"1/2H  
**F:** 135"3/8W x 40"1/8D x 31"1/2H  
**G:** 151"1/8W x 40"1/8D x 31"1/2H  
**H:** 167"W x 40"1/8D x 31"1/2H

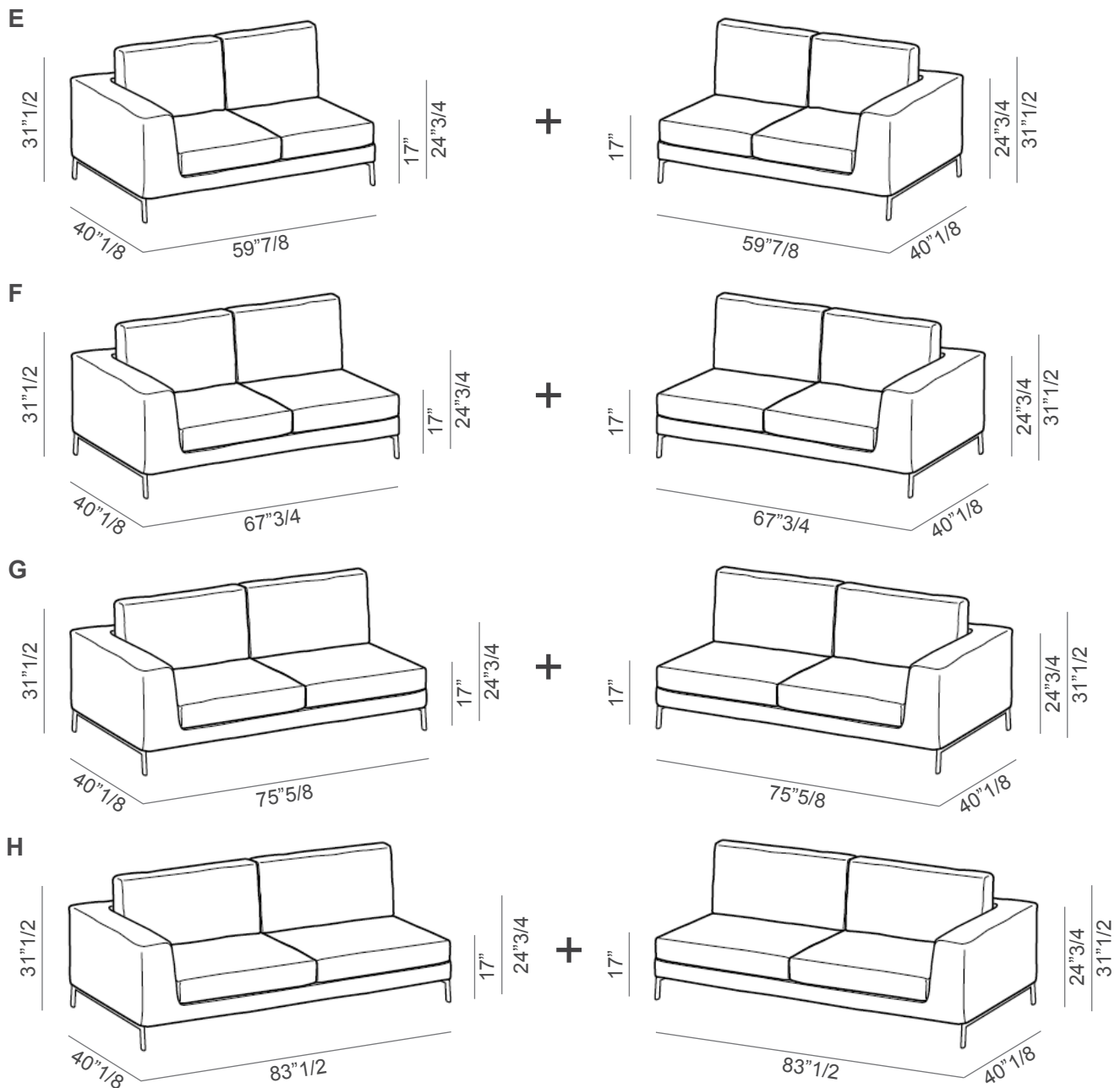

## Artis

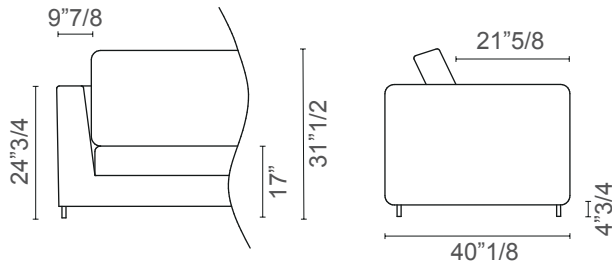

### Feet:

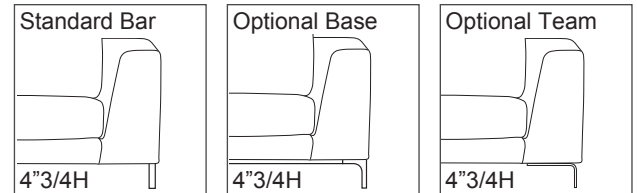

### Internal composition

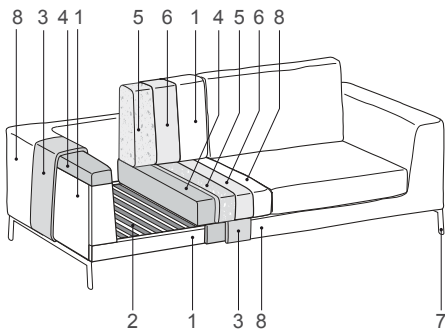

### Seat

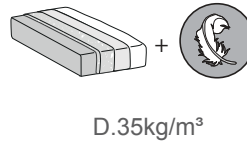

### Backrest



### Structure

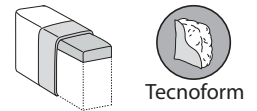

1. Wooden structure
2. Springing
- 3,4,5,6. Padding
7. Feet
8. Upholstery



ECOSY padding in recycled polyester fibers is an alternative to down padding. Available on demand without surcharge.

### Accessories:

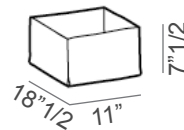
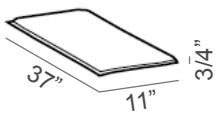

### Optional:

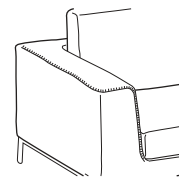

Top in recycled bonded leather



Box in recycled bonded leather



"Punto Pettine" stitching

\* For more specifications, please refer to the "Finishes & Materials" PDF

## Artis

---

### *Decorative cushions* (feather padding)

- 1: 21"5/8W x 5"7/8D x 21"5/8H
- 2: 17"3/4W x 5"7/8D x 17"3/4H
- 3: 17"3/4W x 5"7/8D x 13"3/4H
- 4: 19"5/8W x 5"7/8D x 19"5/8H
- 5: 17"3/4W x 5"7/8D x 14"1/8H
- 6: 18"7/8W x 5"7/8D x 18"7/8H
- 7: 23"5/8W x 5"7/8D x 11"7/8H
- 8: 23"5/8W x 5"7/8D x 23"5/8H
- 9: Ø19"5/8 x 5"7/8D

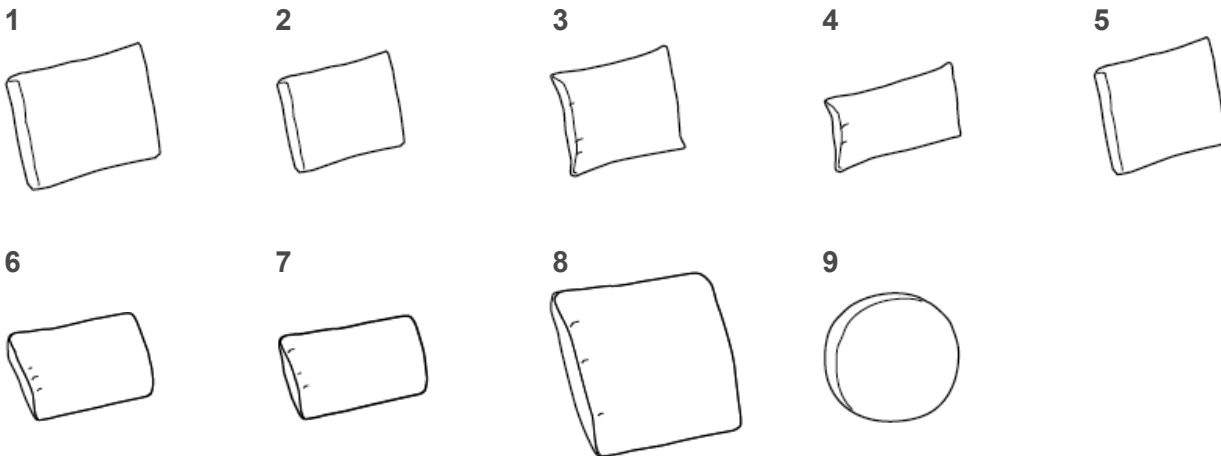

\* For more specifications, please refer to the "Finishes & Materials" PDF