

Krisby

Design: Stefano Spessotto



Description

Sofa with structure in solid wood panels, plywood and laminated solid fir bearing various thicknesses. The backrest is made of multilayered wood or E1 class wood particleboard panels and available in two heights. Seat with pre-tensioned crossed propylene fibers and latex elastic webbing. Padded structure with removable covers in fabric or non removable in eco-leather and leather. Seat and backrest cushions with removable covers in fabric, eco-leather and leather. A mix version with leather structure and fabric cushions is also available. Metal feet. Decorative cushions and quilted armrests are available on demand. Made in Italy.



* For more specifications, please refer to the "Finishes & Materials" PDF

Krisby

HIGH

Dimensions

A: 69"1/4W x 39"3/8D x 33"1/2H

B: 78"W x 39"3/8D x 33"1/2H

C: 86"5/8W x 39"3/8D x 33"1/2H

D: 95"1/4W x 39"3/8D x 33"1/2H

A

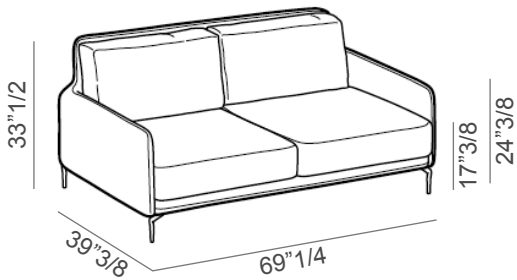

B

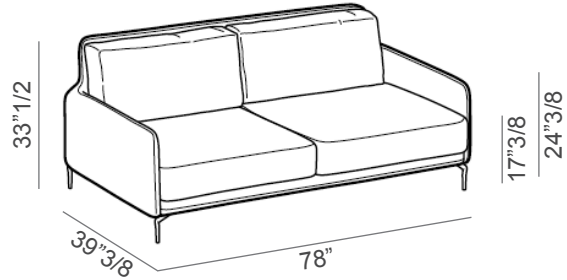

C

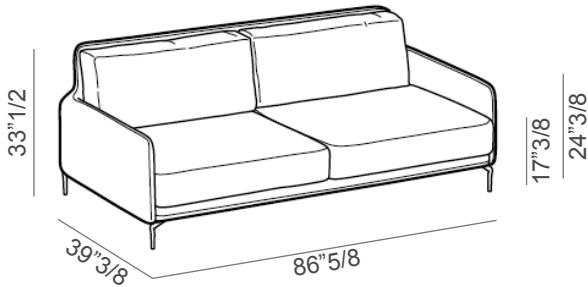

D

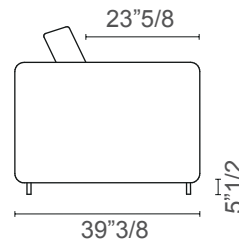
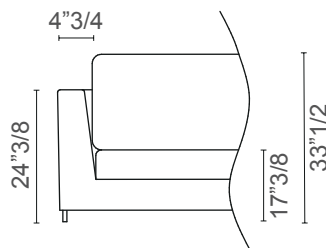
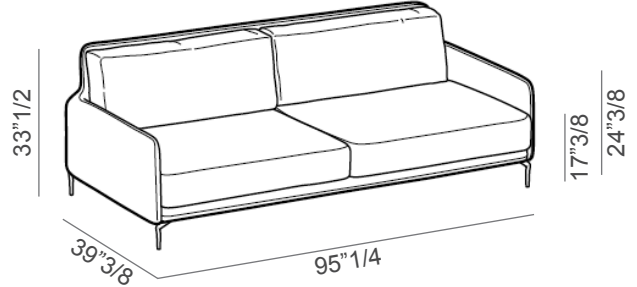

* For more specifications, please refer to the "Finishes & Materials" PDF

Krisby

LOW

Dimensions

E: 69"1/4W x 39"3/8D x 31"7/8H

F: 78"W x 39"3/8D x 31"7/8H

G: 86"5/8W x 39"3/8D x 31"7/8H

H: 95"1/4W x 39"3/8D x 31"7/8H

E

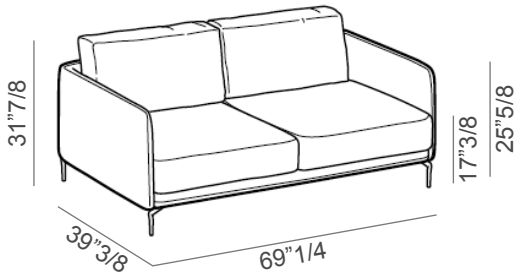

F

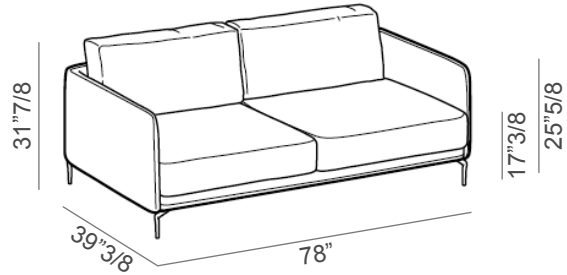

G

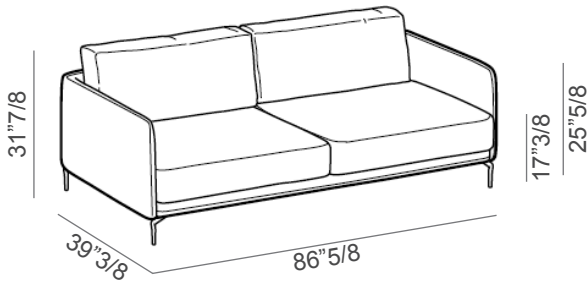

H

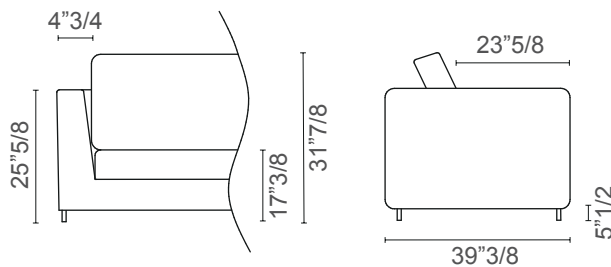
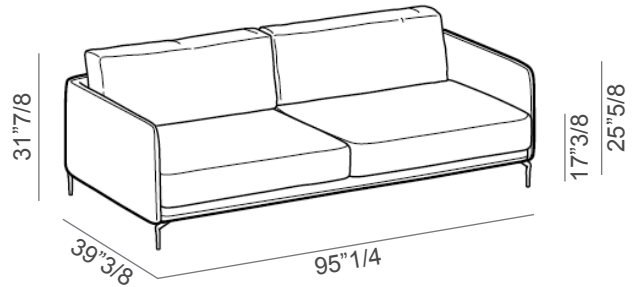

* For more specifications, please refer to the "Finishes & Materials" PDF

Krisby

Internal composition

HIGH

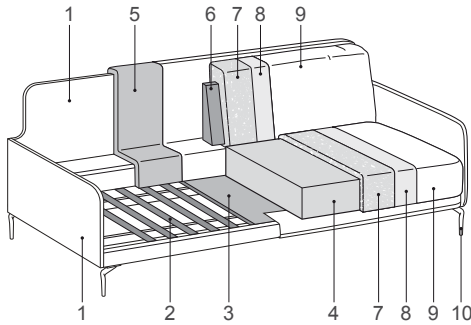

LOW

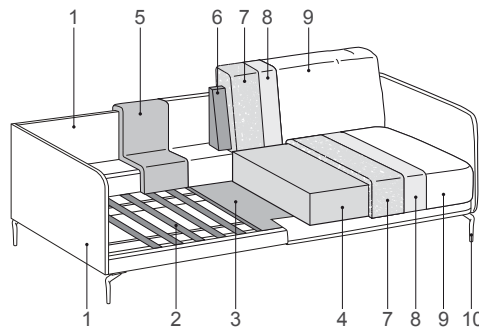

1. Wooden structure
2. Springing
- 4,5,6,7,8. Padding
9. Upholstery
10. Feet

Seat

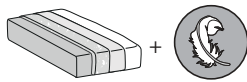

D.35kg/m³

Backrest

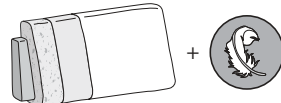

D.21kg/m³

Structure

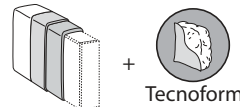

Polyurethane foam
Tecniform



ECOSY padding in recycled polyester fibers is an alternative to down padding. Available on demand without surcharge.

Feet

standard TAG



5"1/2H

optional UP



5"1/2-7"1/2H

optional Bjorg



5"1/8H

Decorative cushions

1: 21"5/8W x 4"D x 11"7/8H

2: 21"5/8W x 4"D x 21"5/8H

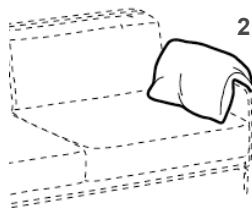
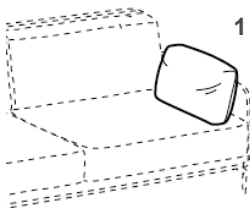

Quilted or leather armrests

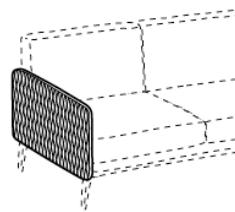

* For more specifications, please refer to the "Finishes & Materials" PDF