

Loman

Design: Stefano Spessotto & Lorella Agnoletto



Description

Sectional with supporting structure in pinewood of various thicknesses. Remaining parts in E1 class particleboard panels. Details in hardboard or cellulose wood-based panels. Backrest in hard or cellulose wooden fiber panels. The seat is supported by propylene and latex elastic belts. Padded structure with removable covers in fabric or non removable in eco-leather and leather. Padded seat and backrest cushions with removable covers in fabric, eco-leather and leather. Metal back support covered with fabric, eco-leather or removable leather. Decorative cushions and metal side table available on demand. Made in Italy.



* For more specifications, please refer to the "Finishes & Materials" PDF

Loman

Suggested compositions

Composition 1

232"1/4W x 142"1/2D x 31"1/2H

2x

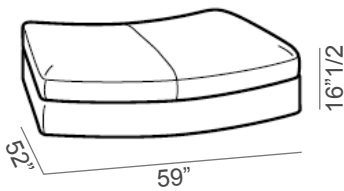

4x

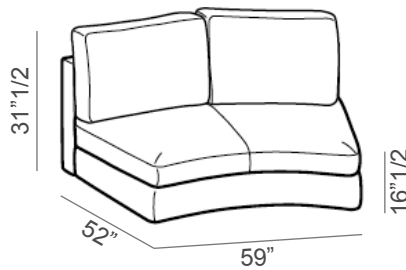

1x

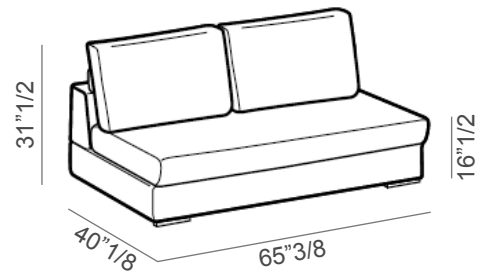

Composition 2

167"W x 92"1/8D x 31"1/2H

2x

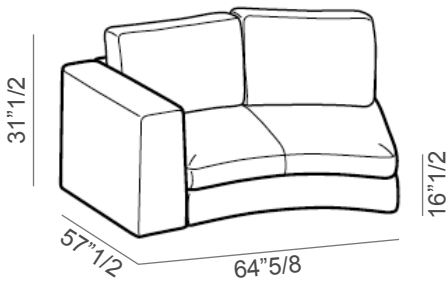

2x

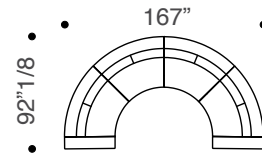
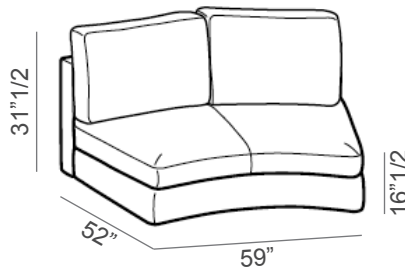

Composition 3

129"1/8W x 57"1/2D x 31"1/2H

2x

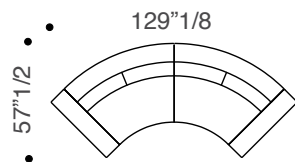
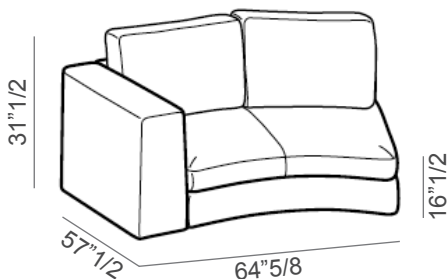

* For more specifications, please refer to the "Finishes & Materials" PDF

Loman

Composition 4

163"W x 57"1/2"D x 31"1/2"H

2x

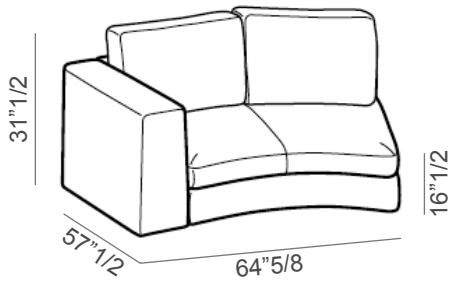

1x

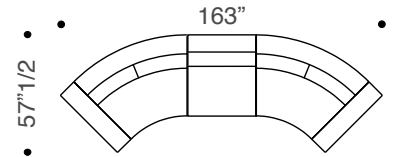
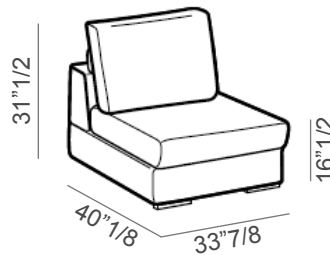

Composition 5

220"7/8W x 128"3/4D x 31"1/2H

2x

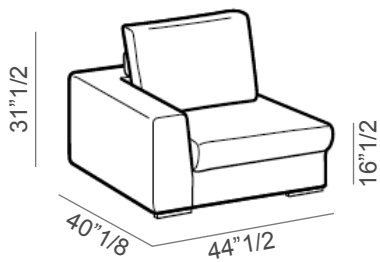

2x

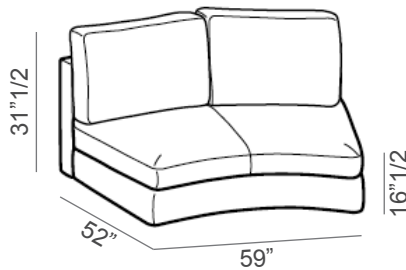

1x

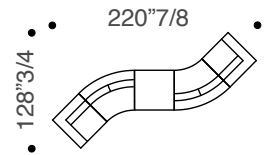
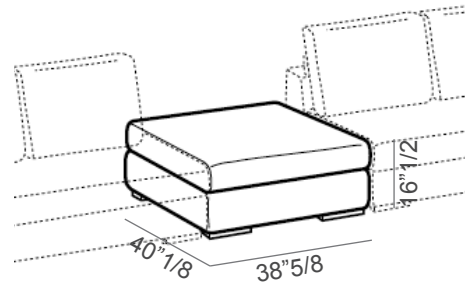

Composition 6

207"W x 110"5/8D x 31"1/2H

1x

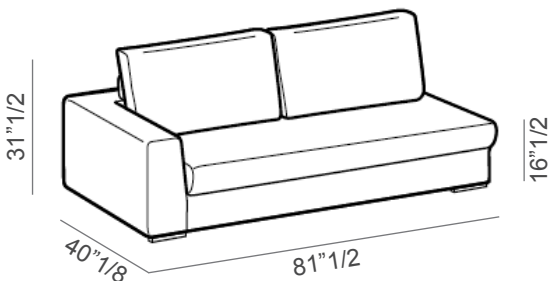

2x

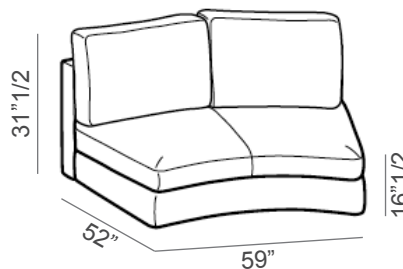

1x

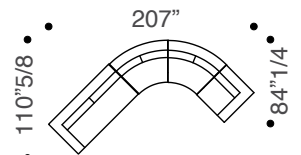
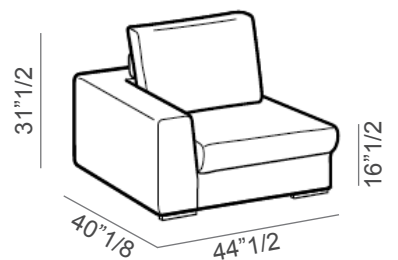

Loman

Composition 7

135"W x 84"1/4"D x 31"1/2"H

2x

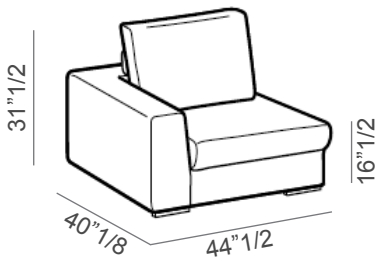

1x

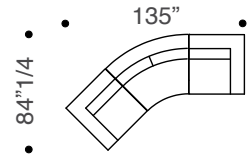
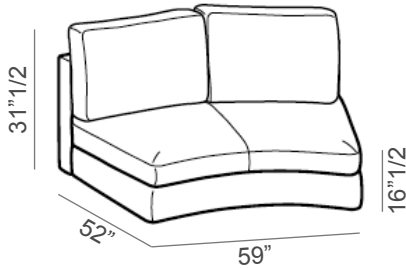

Composition 8

144"1/2"W x 57"1/2"D x 31"1/2"H

1x

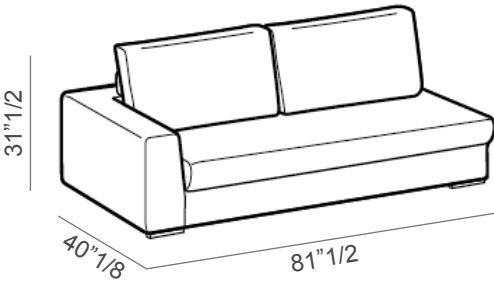

1x

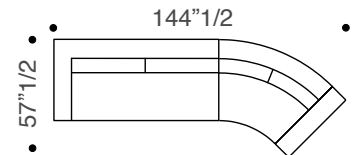
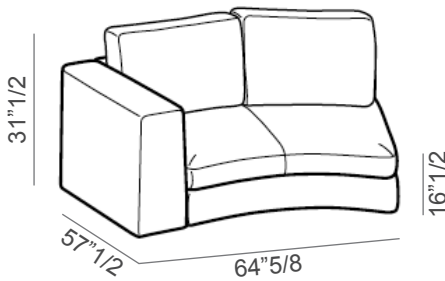

Composition 9

164"1/8"W x 66"1/8"D x 31"1/2"H

1x

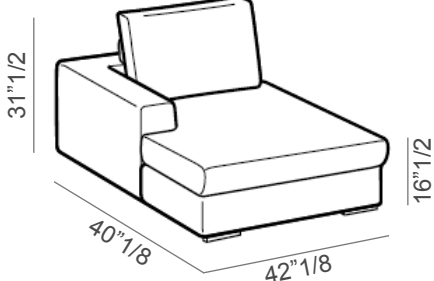

1x

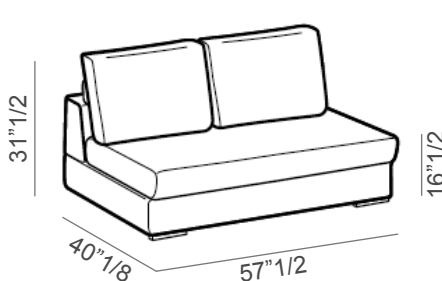

1x

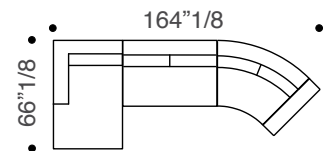
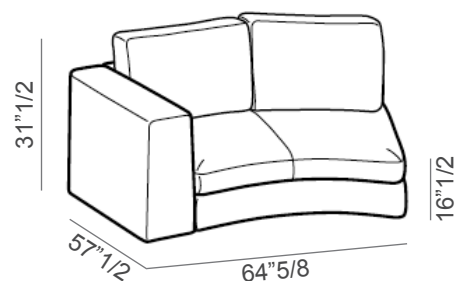

Loman

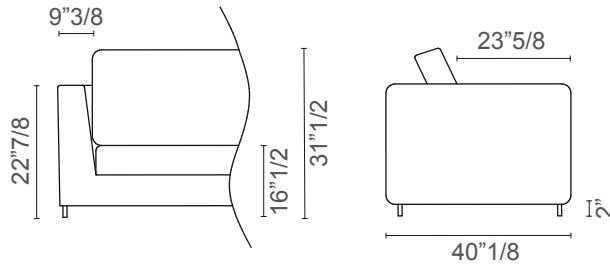

Internal composition

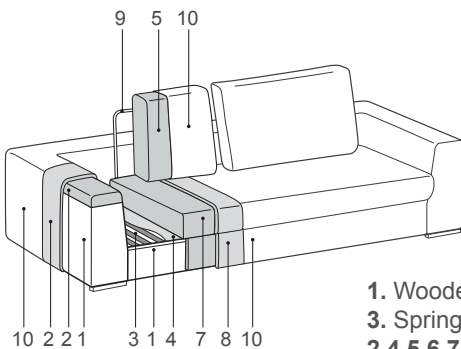

- 1. Wooden structure
- 3. Springing
- 2,4,5,6,7,8. Padding
- 9. Metal back support
- 10. Upholstery

Seat

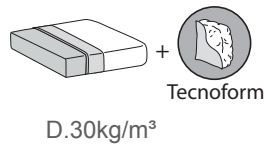

Backrest



Structure

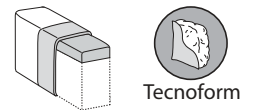

ECOSY padding in recycled polyester fibers is an alternative to down padding. Available on demand without surcharge.

Feet

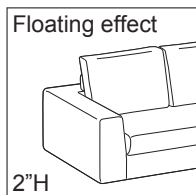

Accessory

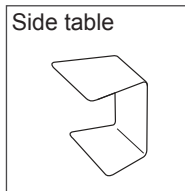

* For more specifications, please refer to the "Finishes & Materials" PDF

Loman

Decorative cushions (feather padding)

- 1: 21"5/8W x 5"7/8D x 21"5/8H
- 2: 17"3/4W x 5"7/8D x 17"3/4H
- 3: 17"3/4W x 5"7/8D x 13"3/4H
- 4: 19"5/8W x 5"7/8D x 19"5/8H
- 5: 17"3/4W x 5"7/8D x 14"1/8H
- 6: 18"7/8W x 5"7/8D x 18"7/8H
- 7: 23"5/8W x 5"7/8D x 11"7/8H
- 8: 23"5/8W x 5"7/8D x 23"5/8H
- 9: Ø19"5/8 x 5"7/8D

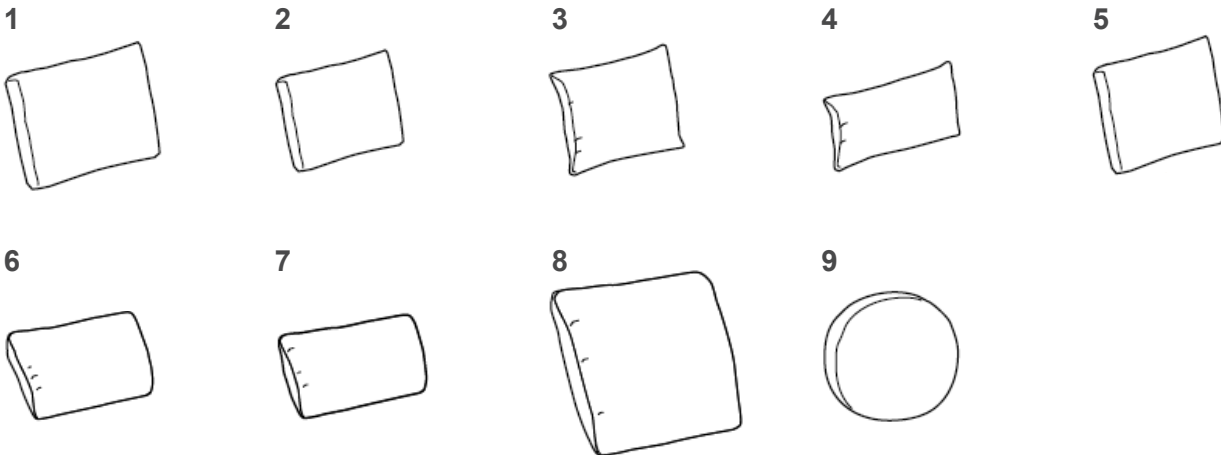

* For more specifications, please refer to the "Finishes & Materials" PDF