

## Loman

*Design: Stefano Spessotto & Lorella Agnoletto*



### *Description*

Sofa with supporting structure in pinewood of various thicknesses. Remaining parts in E1 class particleboard panels. Details in hardboard or cellulose wood-based panels. Backrest in hard or cellulose wooden fiber panels. The seat is supported by propylene and latex elastic belts. Padded structure with removable covers in fabric or non removable in eco-leather and leather. Padded seat and backrest cushions with removable covers in fabric, eco-leather and leather. Metal back support covered with fabric, eco-leather or removable leather. Decorative cushions, a lacquered steel top, bookcase and side table are available on demand. Made in Italy.



\* For more specifications, please refer to the "Finishes & Materials" PDF

## Loman

### Dimensions

**A:** 65<sup>3</sup>/<sub>8</sub>W x 40<sup>1</sup>/<sub>8</sub>D x 31<sup>1</sup>/<sub>2</sub>H

**B:** 73<sup>1</sup>/<sub>4</sub>W x 40<sup>1</sup>/<sub>8</sub>D x 31<sup>1</sup>/<sub>2</sub>H

**C:** 81"W x 40<sup>1</sup>/<sub>8</sub>D x 31<sup>1</sup>/<sub>2</sub>H

**D:** 89"W x 40<sup>1</sup>/<sub>8</sub>D x 31<sup>1</sup>/<sub>2</sub>H

**E:** 93<sup>1</sup>/<sub>4</sub>W x 40<sup>1</sup>/<sub>8</sub>D x 31<sup>1</sup>/<sub>2</sub>H

**F:** 93<sup>1</sup>/<sub>4</sub>W x 40<sup>1</sup>/<sub>8</sub>D x 31<sup>1</sup>/<sub>2</sub>H

**G:** 101<sup>1</sup>/<sub>8</sub>W x 40<sup>1</sup>/<sub>8</sub>D x 31<sup>1</sup>/<sub>2</sub>H

**H:** 101<sup>1</sup>/<sub>8</sub>W x 40<sup>1</sup>/<sub>8</sub>D x 31<sup>1</sup>/<sub>2</sub>H

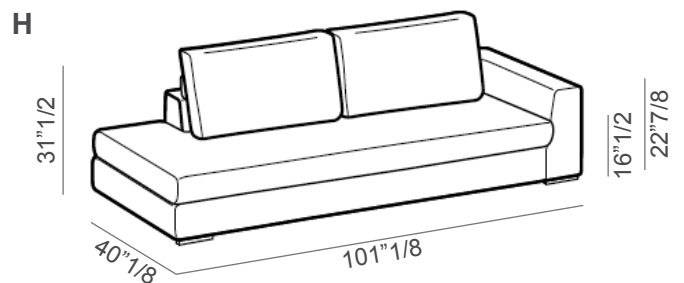
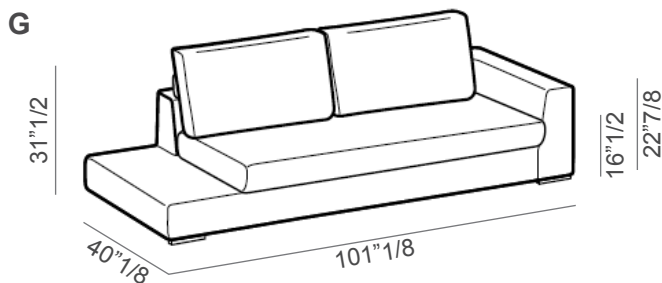
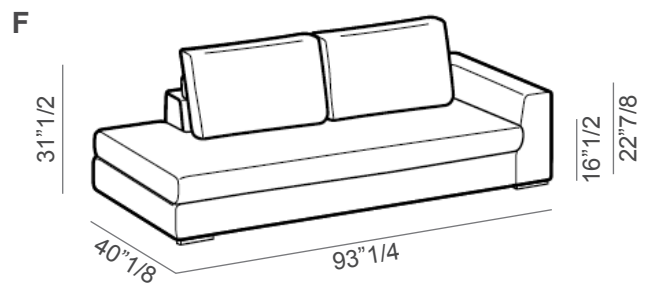
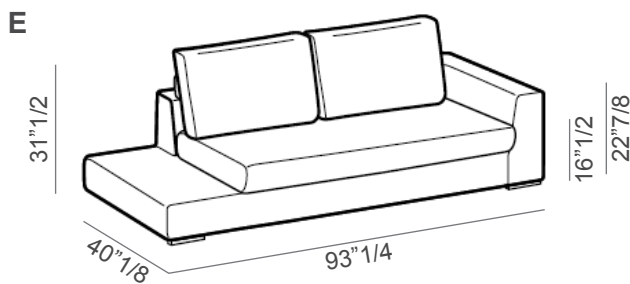
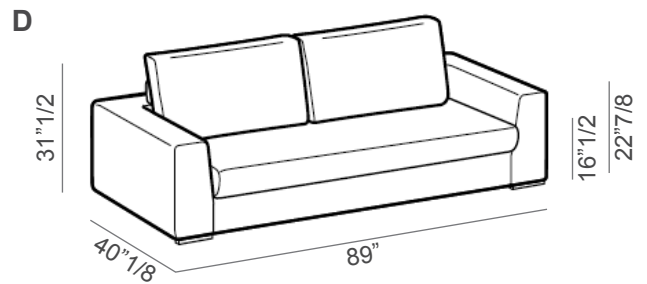
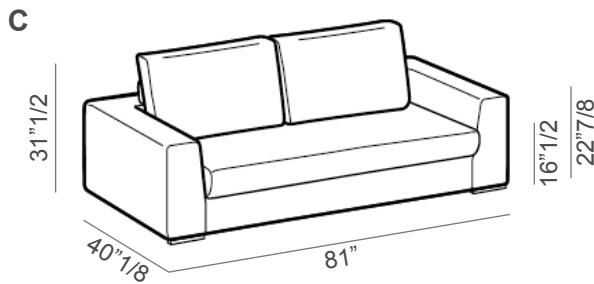
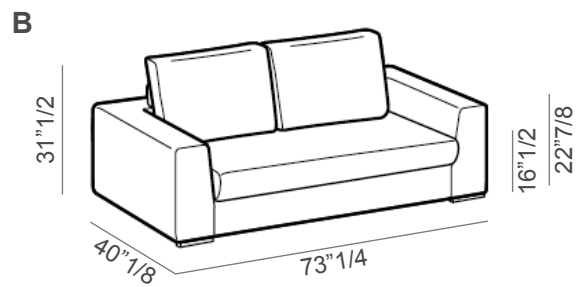
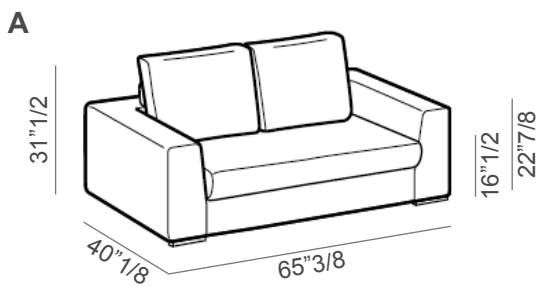

\* For more specifications, please refer to the "Finishes & Materials" PDF

## Loman

### Internal composition

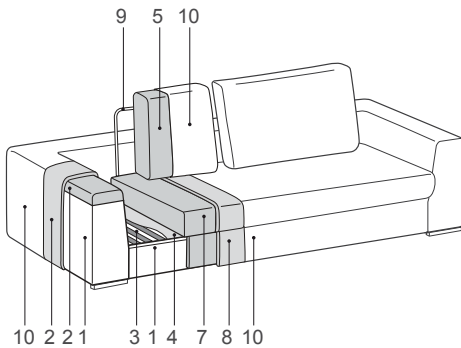

- 1. Wooden structure
- 3. Springing
- 2,4,5,6,7,8. Padding
- 9. Metal backrest
- 10. Upholstery

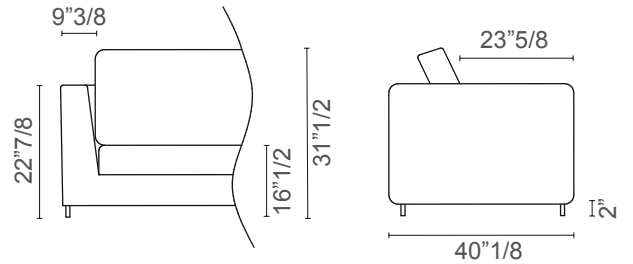

### Seat

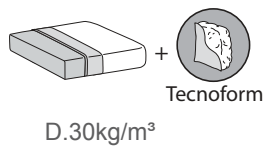

### Backrest



### Structure

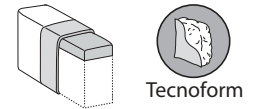

ECOSY padding in recycled polyester fibers is an alternative to down padding. Available on demand without surcharge.

### Feet

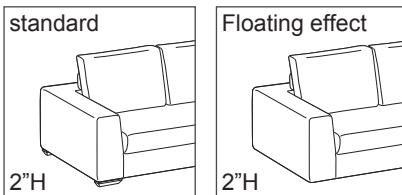

### Accessories

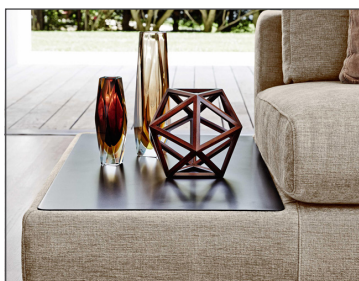
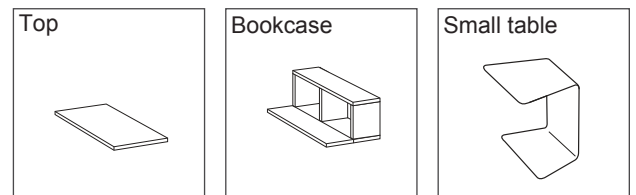

\* For more specifications, please refer to the "Finishes & Materials" PDF

## Drop

---

### *Decorative cushions* (feather padding)

- 1: 21"5/8W x 5"7/8D x 21"5/8H
- 2: 17"3/4W x 5"7/8D x 17"3/4H
- 3: 17"3/4W x 5"7/8D x 13"3/4H
- 4: 19"5/8W x 5"7/8D x 19"5/8H
- 5: 17"3/4W x 5"7/8D x 14"1/8H
- 6: 18"7/8W x 5"7/8D x 18"7/8H
- 7: 23"5/8W x 5"7/8D x 11"7/8H
- 8: 23"5/8W x 5"7/8D x 23"5/8H
- 9: Ø19"5/8 x 5"7/8D

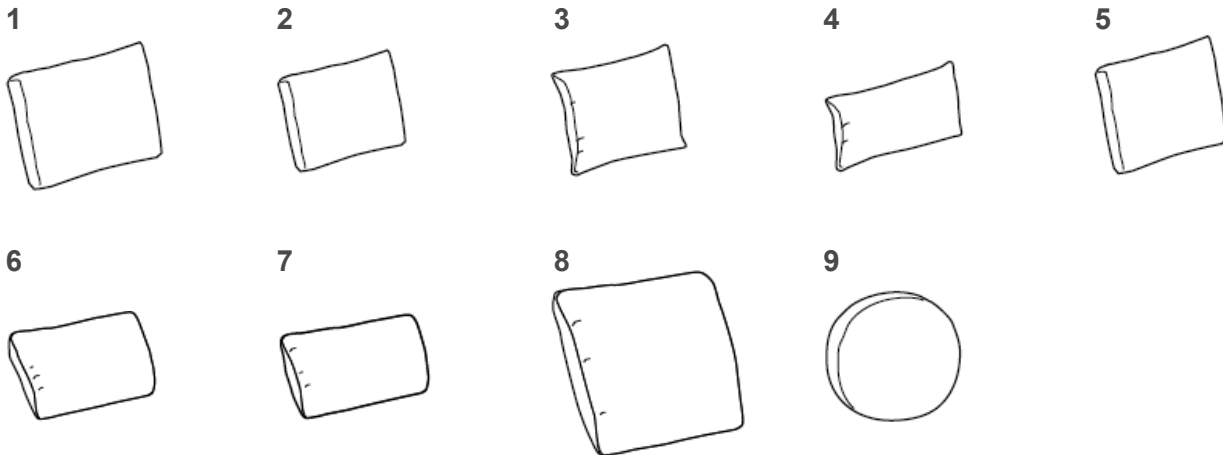

\* For more specifications, please refer to the "Finishes & Materials" PDF