

Unit

Design: Daniele Lo Scalzo Moscheri



Description

Modular storage unit composed of a metal base, a central storage unit and a showcase with metal frame on top. The base of the showcase is available in stoneware or bonded leather, while the top is available in glass, stoneware or bonded leather. Central storage units in lacquered or veneered MDF are available with a flap door, two doors or with a drawer, and are finished at sight on the back. Storage units should not be put directly on the ground, they were designed to be put on the bases or on top of another storage unit. It is advisable to stack a maximum of three storage units. Made in Italy.



* For more specifications, please refer to the "Finishes & Materials" PDF

Unit

Suggested compositions

Composition 1

78"3/4W x 20"1/4D x 15"3/4H

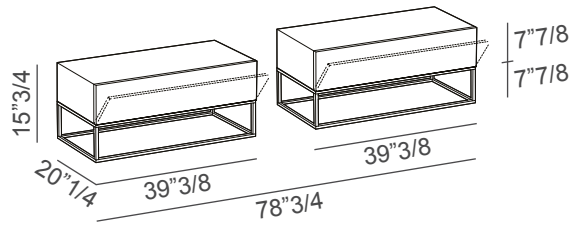

Composition 2

78"3/4W x 20"1/4D x 31"1/2H

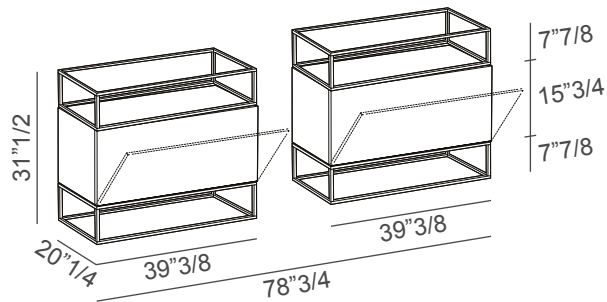
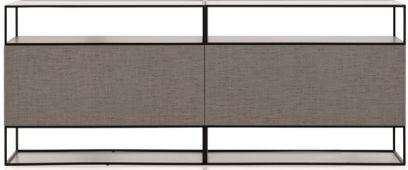

Composition 3

39"3/8W x 20"1/4D x 47"1/4H

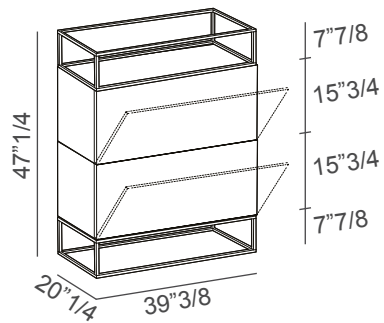

* For more specifications, please refer to the "Finishes & Materials" PDF

Unit

Composition 4

118"1/8W x 20"1/4D x 23"5/8H

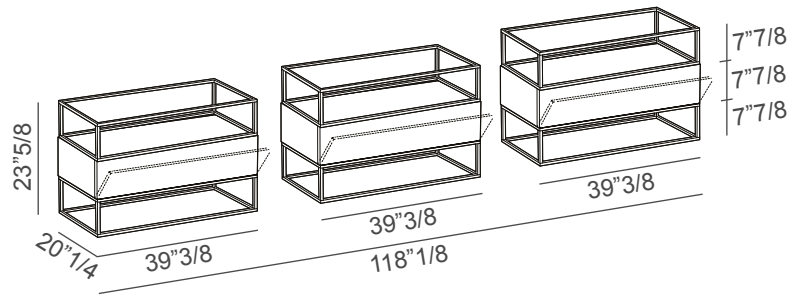

Composition 5

118"1/8W x 20"1/4D x 23"5/8H

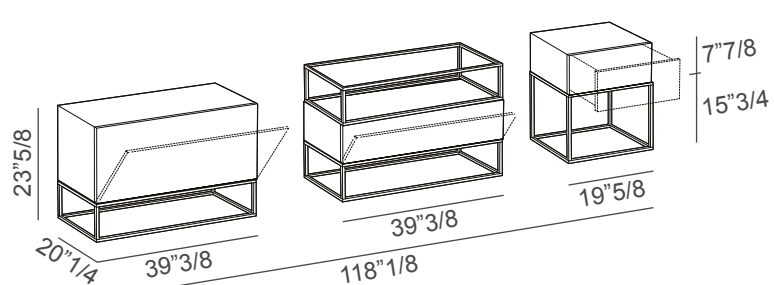

* For more specifications, please refer to the "Finishes & Materials" PDF

Unit

Available modules

Bases

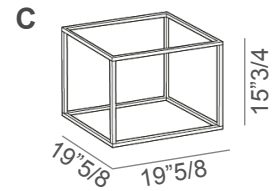
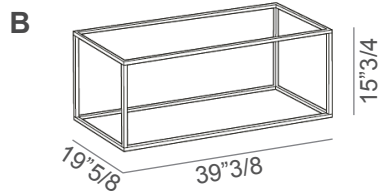
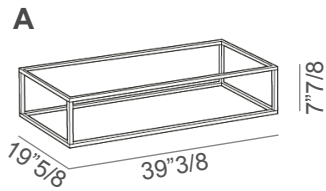

Storage units

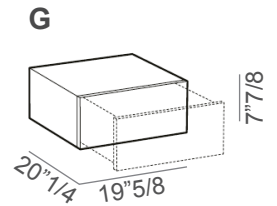
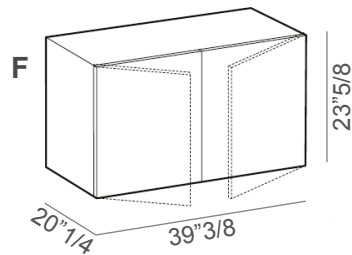
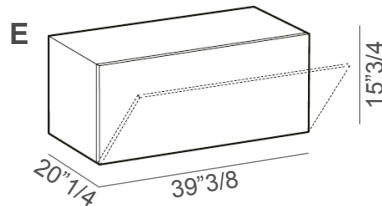
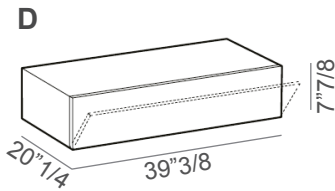

Showcase

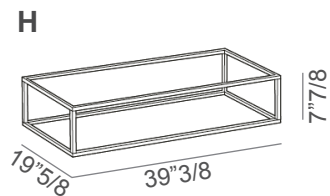

* For more specifications, please refer to the "Finishes & Materials" PDF