

Adam

Design: Carlo Colombo



Description

Chaise lounge available in three different widths, with left, right or no armrests. Structure in poplar plywood and painted metal in bronze color with a natural effect or black nickel color. Feet in solid beech wood. The external metal structure features completely removable covers in fabric, leather or saddle leather. Paddings are in goose feathers with inserts in flexible multi-density polyurethane and the completely removable covers are in fabric or leather. The following accessories are available for the armrests: left or right covers available in fabric, leather or saddle leather; left or right covers with pockets available in leather or saddle leather; left or right storage box in saddle leather; left or right low table available in canaletto walnut, saddle leather or marble. Decorative feather cushions with removable covers are available on demand. Made in Italy.

* For more specifications, please refer to the "Finishes & Materials" PDF

Adam

Finishes & Materials

External structure: Metal profiles painted in bronze color with a natural effect or in black nickel color.

Structure cover: C.O.M. fabric, C.O.L., fabric Cat. C, D, E, F, G, H, SP or Exclusive; leather Cat. Pelle, Pelle Plus or Anilina; Saddle leather.

Seat & backrest cover: C.O.M. fabric, C.O.L., fabric Cat. C, D, E, F, G, H, SP or Exclusive; leather Cat. Pelle, Pelle Plus or Anilina.

Low tables for armrests: Canaletto walnut in natural (11), grey (2W) or dark (2Z) finish; Saddle leather or Velvet Brown, Zebrino, Grigio Astratto, Gold Calacatta, Purple Calacatta or Portoro marble.

Feet: Solid beech wood.



NOTE:

When ordering, it is possible to buy feet to raise the product by 3/4".
In case of leather upholstery, new stitches will be added as specified in the following drawings:

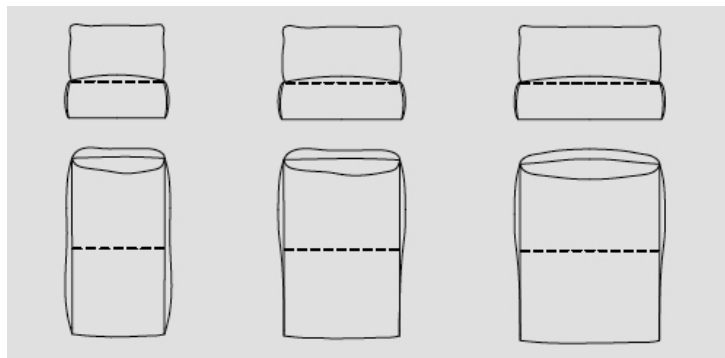

* For more specifications, please refer to the "Finishes & Materials" PDF

Adam

Dimensions

A: 35³/₈W x 63"D x 33"H

B: 43¹/₄W x 63"D x 33"H

C: 51¹/₈W x 63"D x 33"H

A - NO ARMRESTS

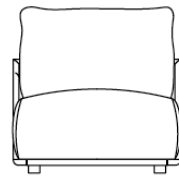

35³/₈

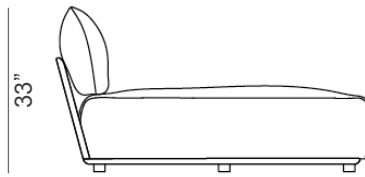

63"

LEFT ARMREST

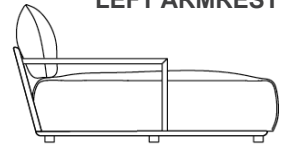

RIGHT ARMREST

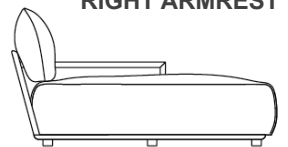

B - NO ARMRESTS

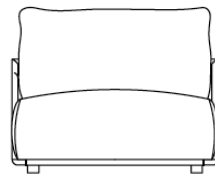

43¹/₄

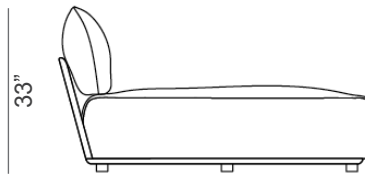

63"

LEFT ARMREST

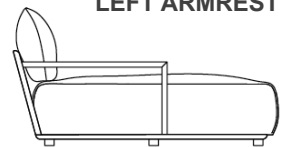

RIGHT ARMREST

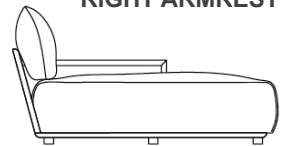

C - NO ARMRESTS

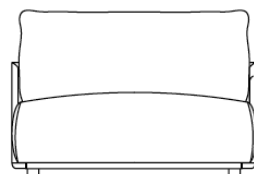

51¹/₈



63"

LEFT ARMREST

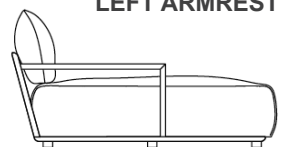

RIGHT ARMREST

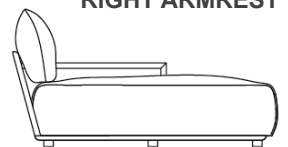

* For more specifications, please refer to the "Finishes & Materials" PDF

Adam

Armrest accessories

Left or right cover:
32"5/8W x 1"1/8D x 20"7/8H

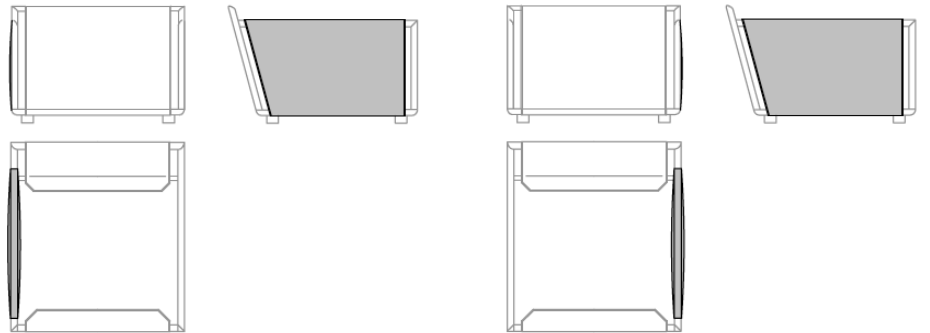

Left or right cover with pockets:
32"5/8W x 2"3/8D x 20"7/8H

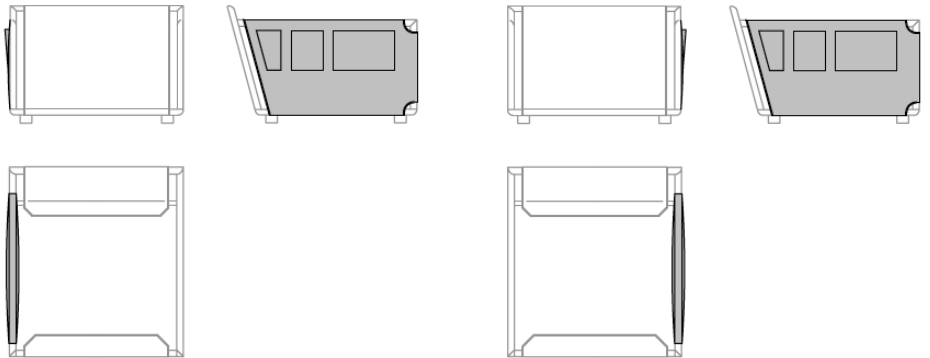

Left or right cover with storage box:
32"5/8W x 9"D x 20"7/8H

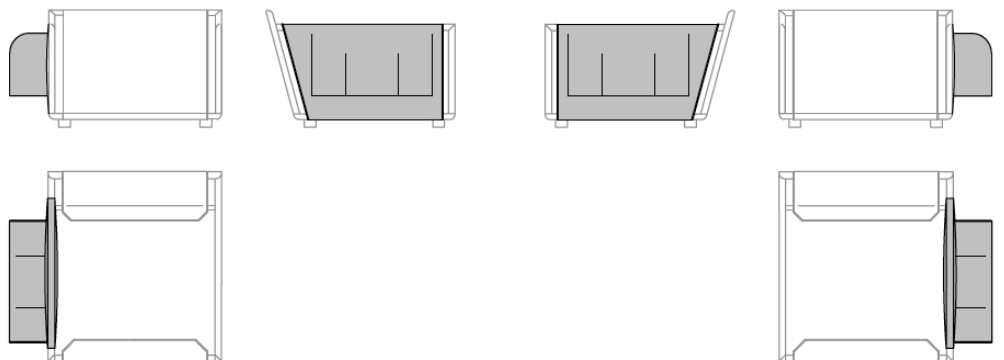

* For more specifications, please refer to the "Finishes & Materials" PDF

Adam

Armrest accessories

**Left or right low table
accessory for armrest:**
8"5/8W x 35"3/8D x 1"3/8H

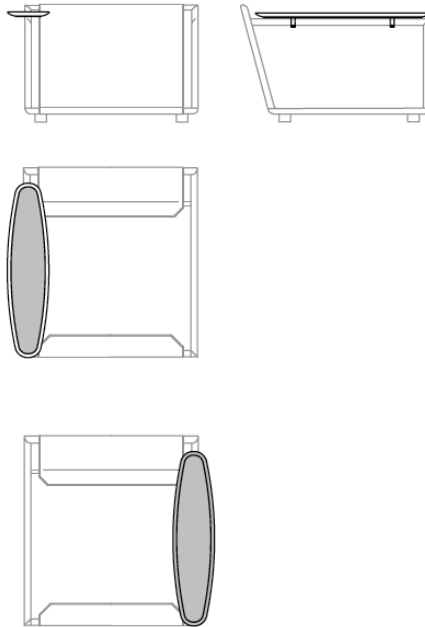

Decorative cushions:



* For more specifications, please refer to the "Finishes & Materials" PDF