

Bamboo

Design: Tulczinsky



Description

Coffee table with base made of transparent Murano glass tubes with black filigree and plinth base in smoke-grey mirror glass. Round, oval, square or rectangular top in extra-clear glass available in 1/2" thick with 45° bevel or in 3/8" thick with polished edges. Made in Italy.

Finishes & Materials

Base: Transparent Murano glass tubes with black filigree.

Plinth base: Smoke-grey mirror glass.

Top: Extra-clear glass available in 1/2" thick with 45° bevel or in 3/8" thick with polished edges.



* For more specifications, please refer to the "Finishes & Materials" PDF

Bamboo

Dimensions

A: Ø41"3/4 x 15"3/4H

B: Ø47"1/4 x 15"3/4H

C: 53"1/8W x 31"1/2D x 15"3/4H

D: 51"1/8W x 51"1/8D x 15"3/4H

E: 55"1/8W x 55"1/8D x 15"3/4H

A 45° bevel

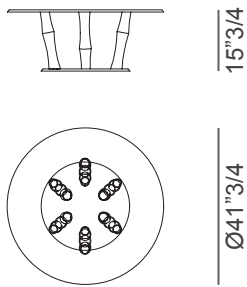

B 45° bevel

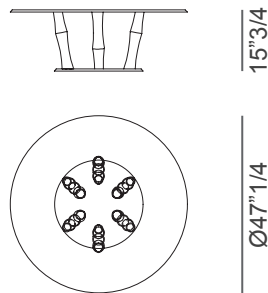

C 45° bevel

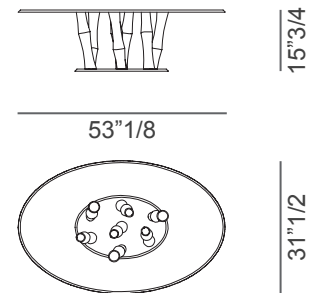

D Polished edges

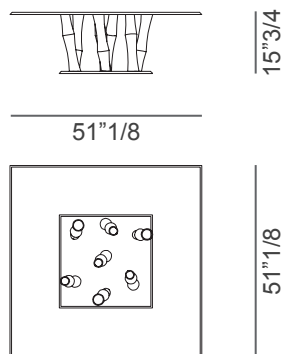

E 45° bevel

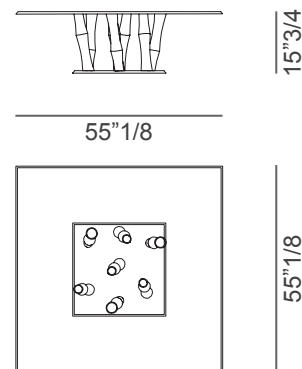

* For more specifications, please refer to the "Finishes & Materials" PDF

Bamboo

Dimensions

F: 47"1/4W x 31"1/2D x 15"3/4H

G: 53"1/8W x 31"1/2D x 15"3/4H

H: 55"1/8W x 31"1/2D x 15"3/4H

I: 70"7/8W x 39"3/8D x 15"3/4H

F Polished edges

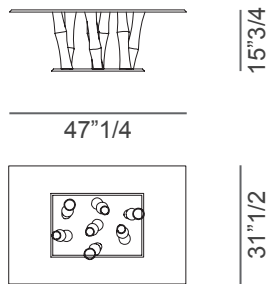

G Polished edges

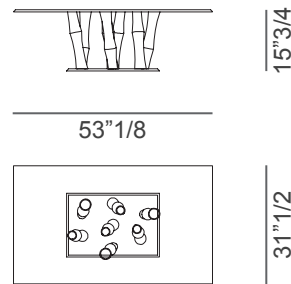

H Polished edges

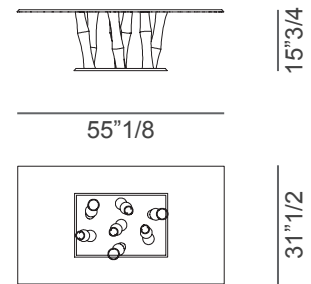

I 45° bevel

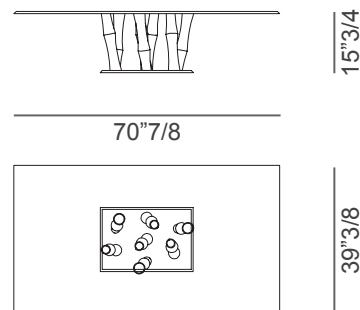

* For more specifications, please refer to the "Finishes & Materials" PDF